

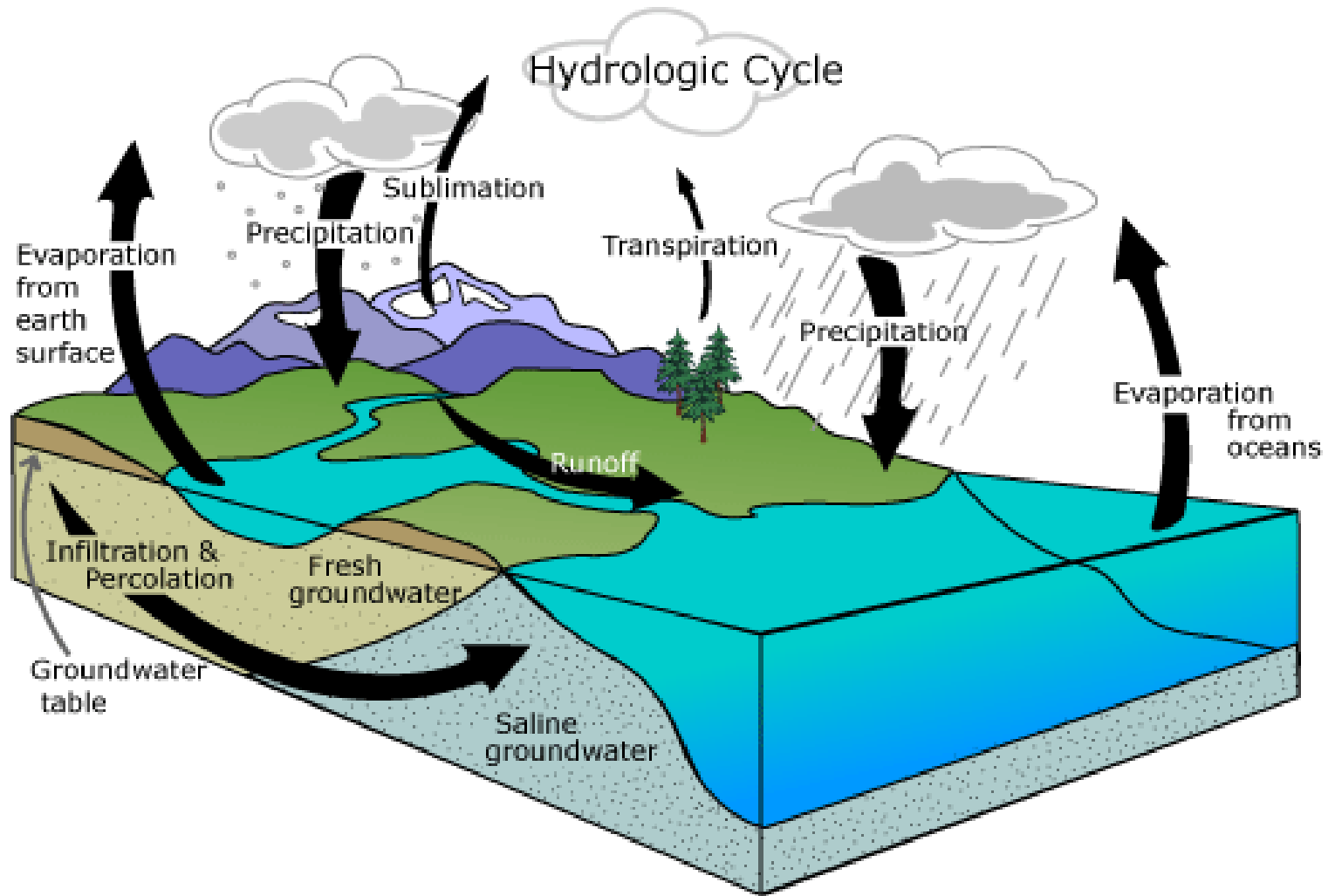

Energia hidroeléctrica

Energias Renováveis

Miguel Centeno Brito





simus & asellus ascendendo dicitur. qd' asellus
dicitur. sed hoc nomen qd' magis equis co
ueniebat: ideo hoc animal simpsit qd'
primum equos capere homines. hunc presider

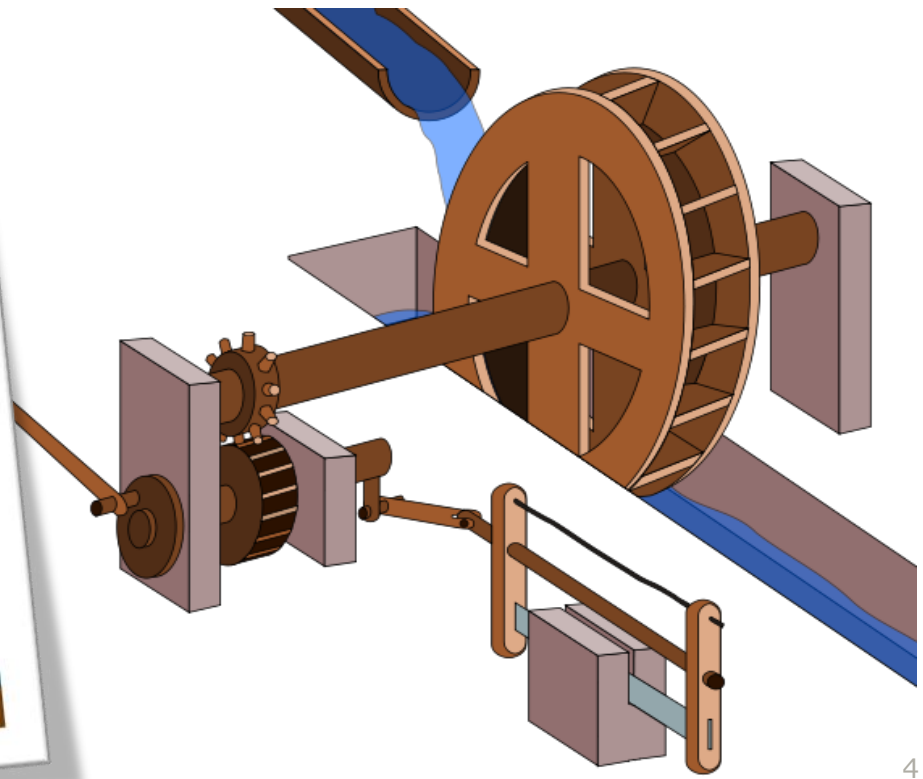
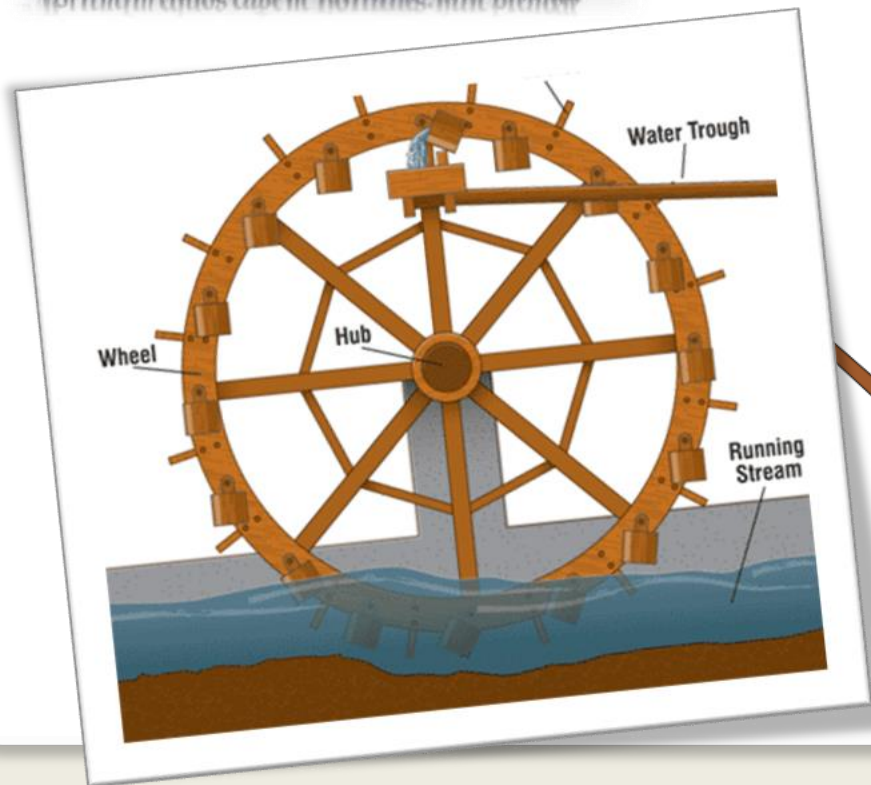
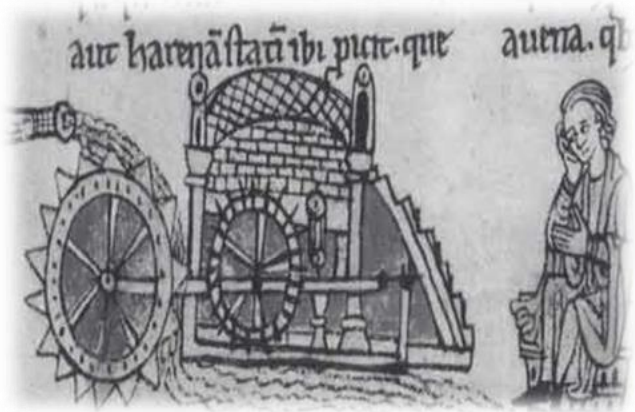

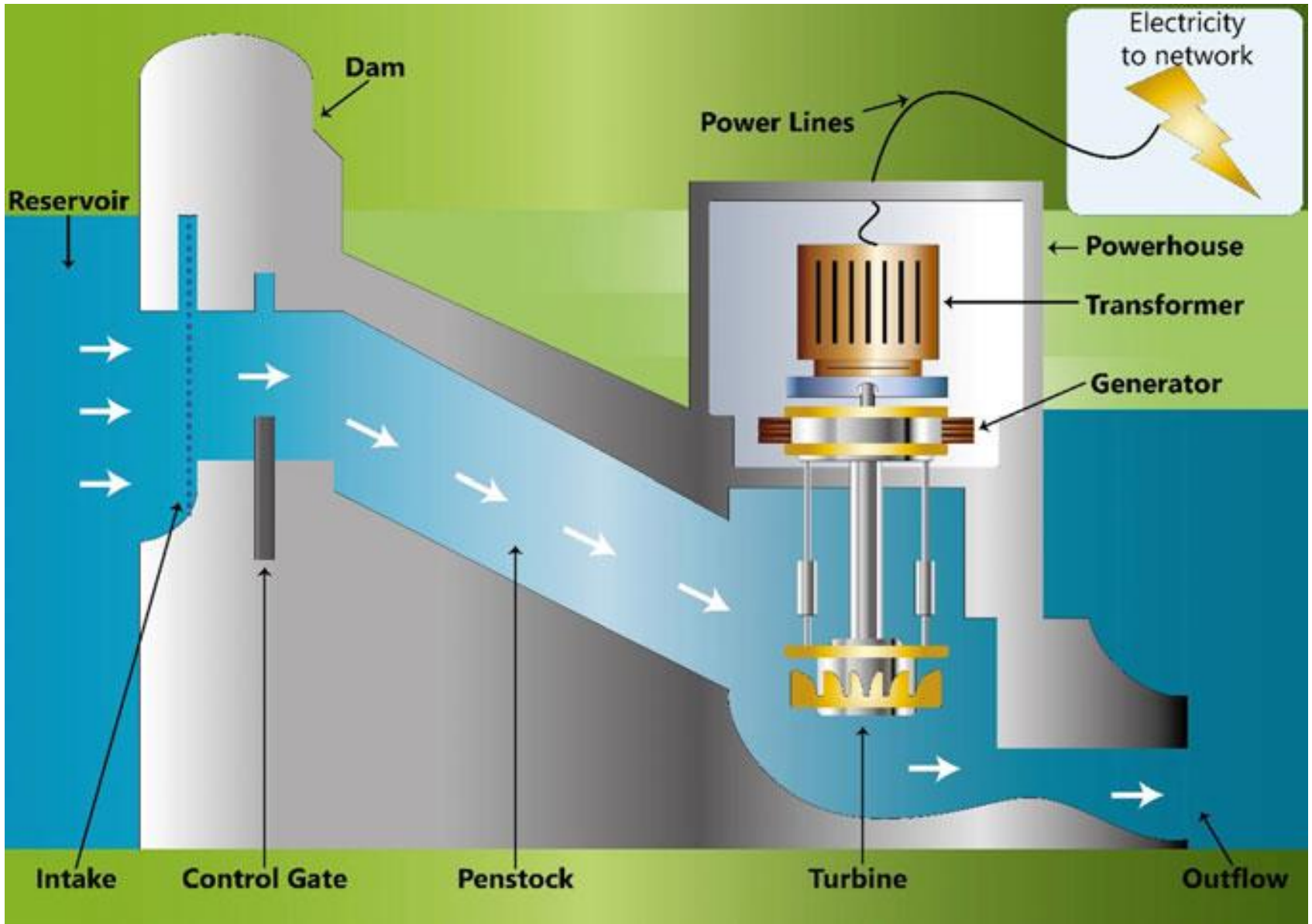

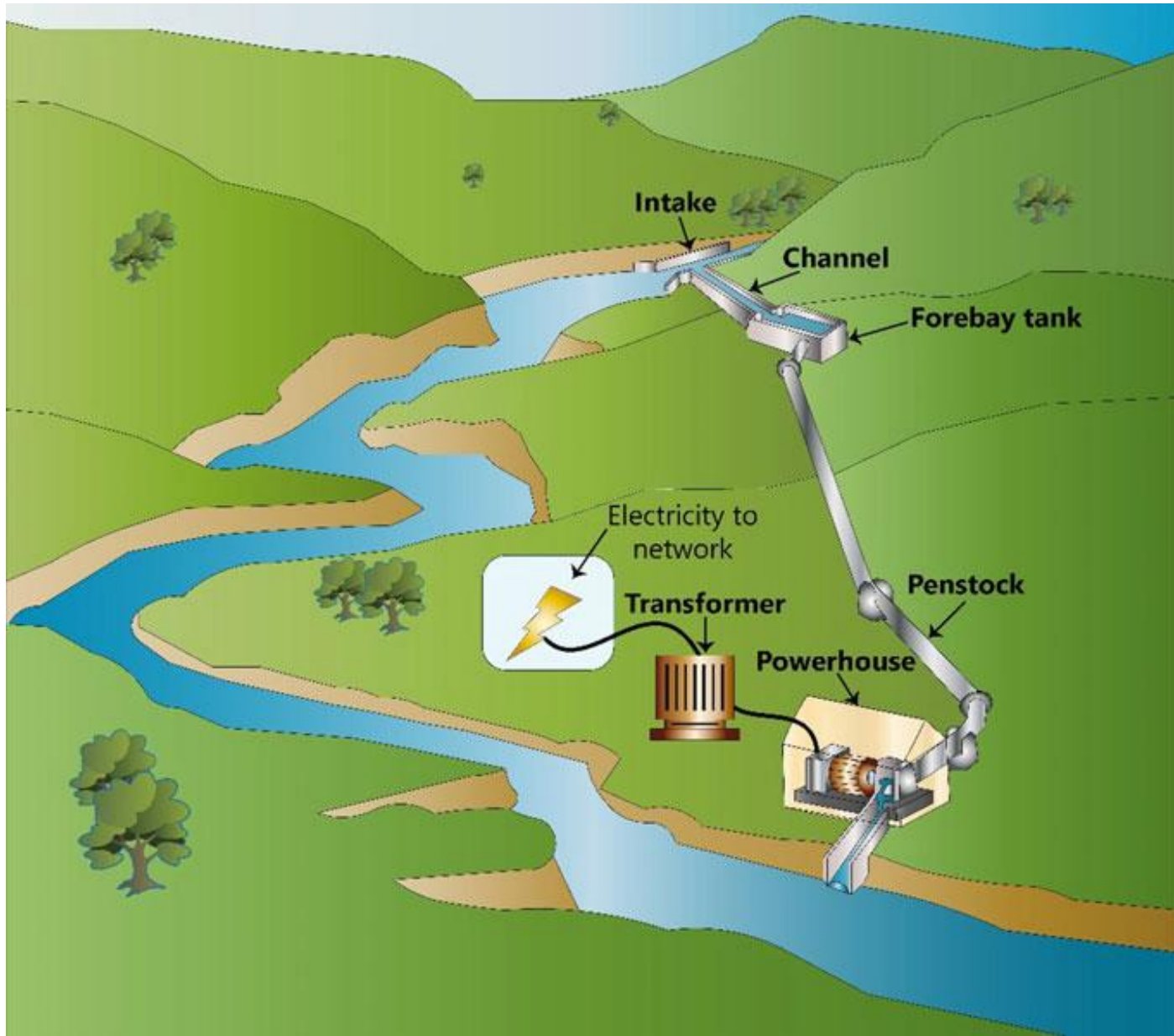

ENERGIA HÍDRICA

Qual a energia potencial gravítica num volume de água?

$$dE_p = (dm)gh = (\rho A dh)$$

$$E_p = \int_0^{h_0} dE_p dh = \int_0^{h_0} \rho A g h dh$$

$$= \rho A g \frac{h_0^2}{2} = \rho (A h_0) g \frac{h_0}{2}$$

$$E_p = \frac{1}{2} \rho V g$$

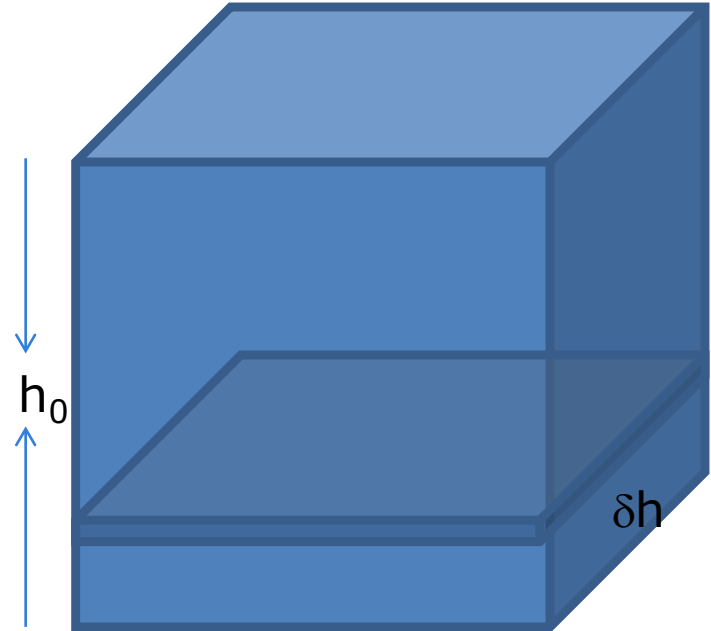

e.g. Alto Rabagão

Área 2200ha;

Desnível 130m;

Produção média anual 115×10^6 kWh

ENERGIA HÍDRICA

Qual a potência mecânica de um curso de água?

$$P_m = \rho g Q h_0$$

$$\left[W = \frac{\text{kg}}{\text{m}^3} \frac{\text{m}}{\text{s}^2} \frac{\text{m}^3}{\text{s}} \text{m} \right]$$

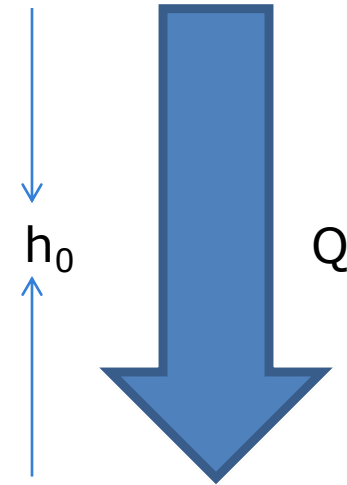

Qual a potência eléctrica produzida por de um curso de água?

$$P_e = \eta_t \eta_e \rho g Q h_0$$

eficiência da turbina (80%) x eficiência gerador (98%)

ENERGIA HÍDRICA

Curva (média) de duração de caudais (médios diários)

Na realidade o caudal não é constante.

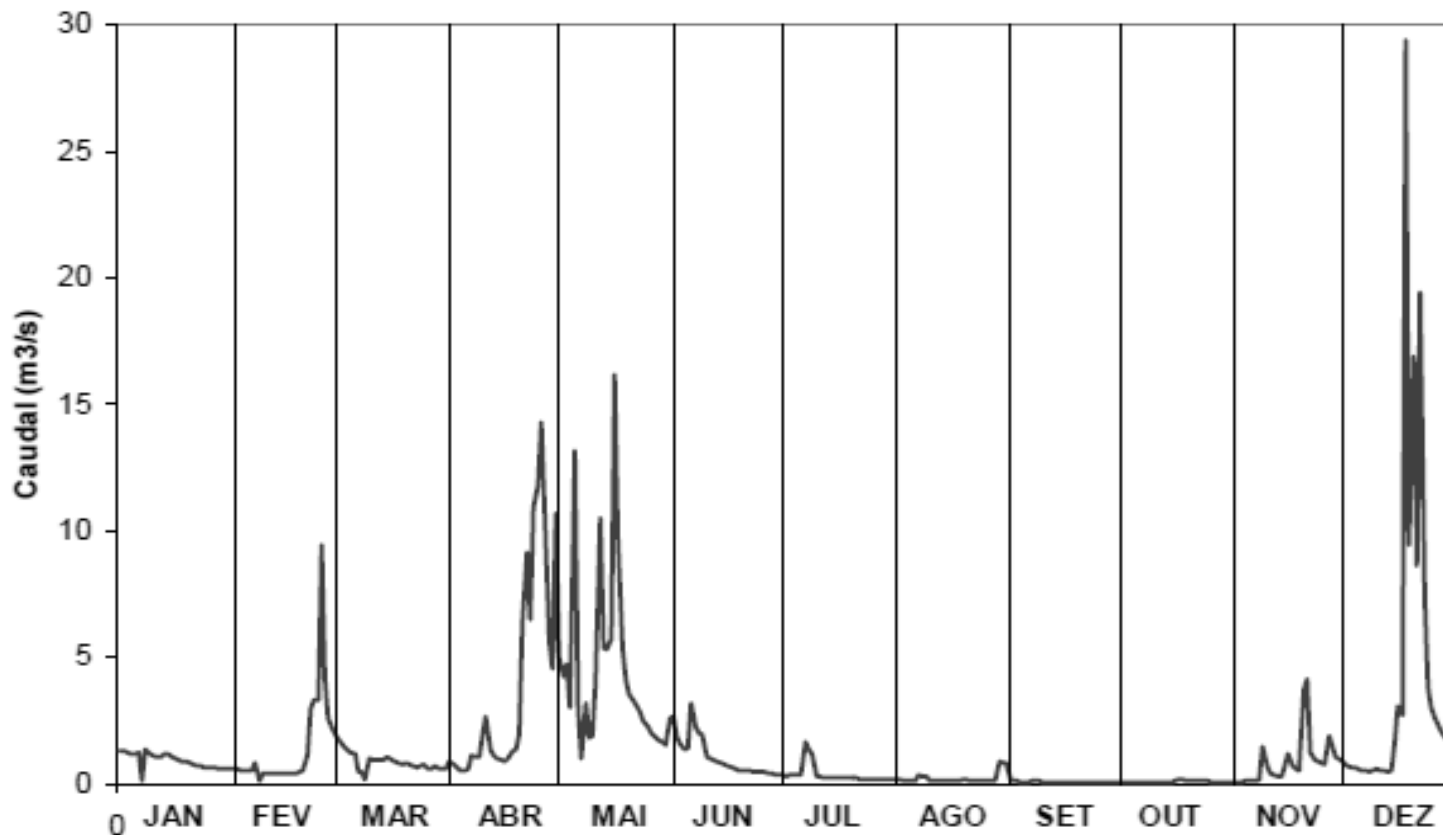

ENERGIA HÍDRICA

Curva (média) de duração de caudais (médios diários)

Na realidade o caudal não é constante.

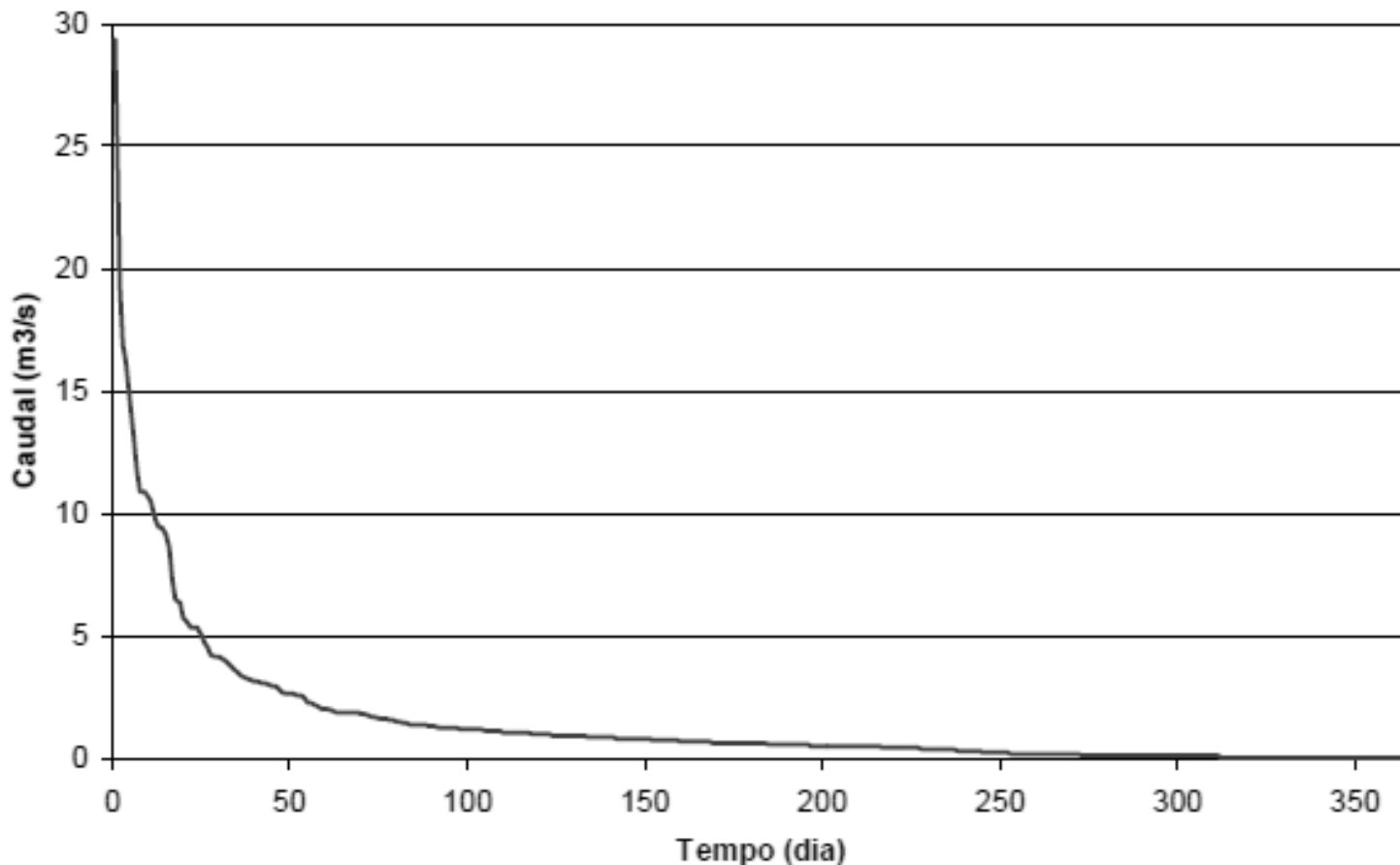

ENERGIA HÍDRICA

Curva (média) de duração de caudais (médios diários)

Na realidade o caudal não é constante.

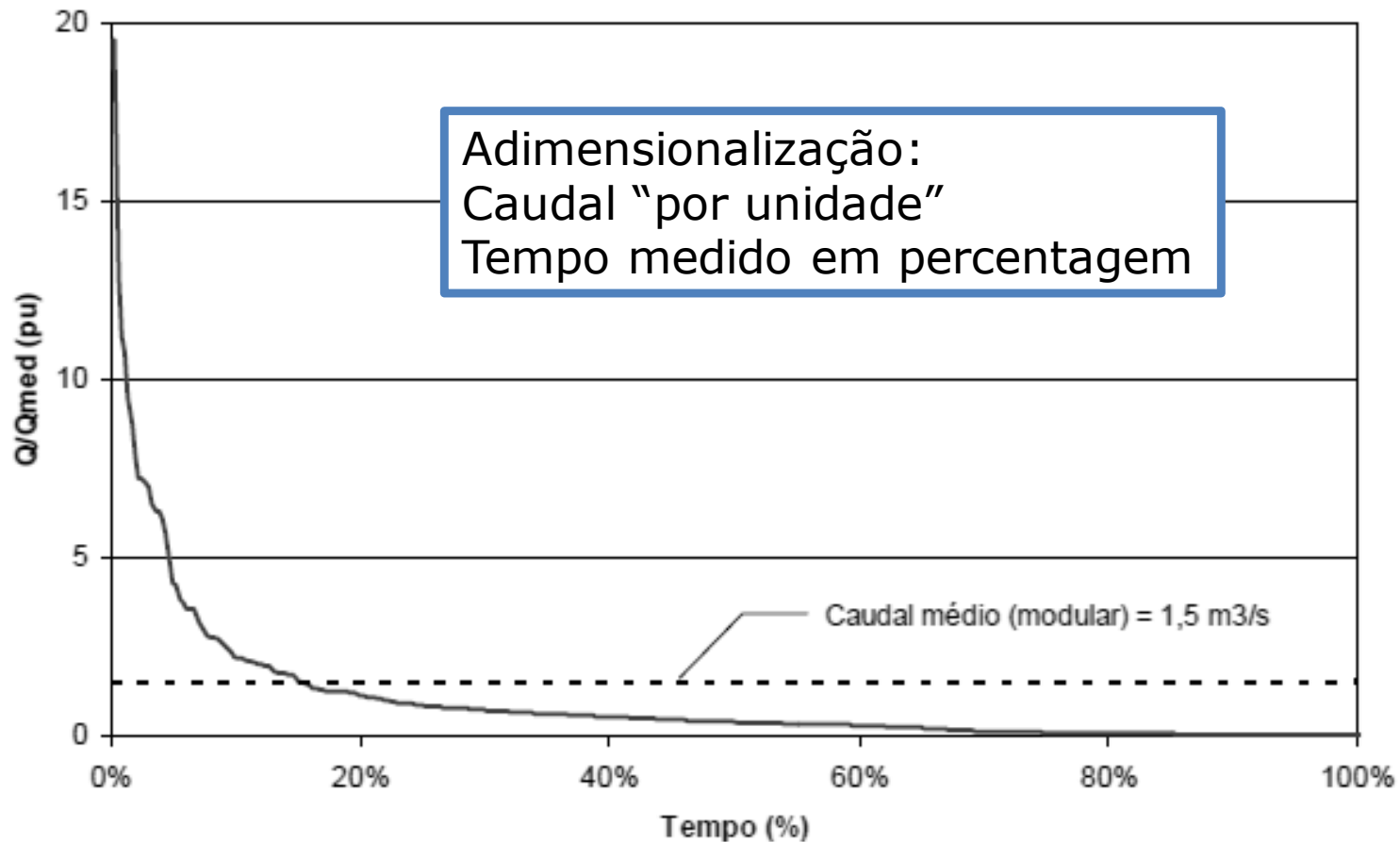

TIPOS DE APROVEITAMENTO HIDROELÉCTRICOS

Fio de água ou

Albufeira, reversível ou não.

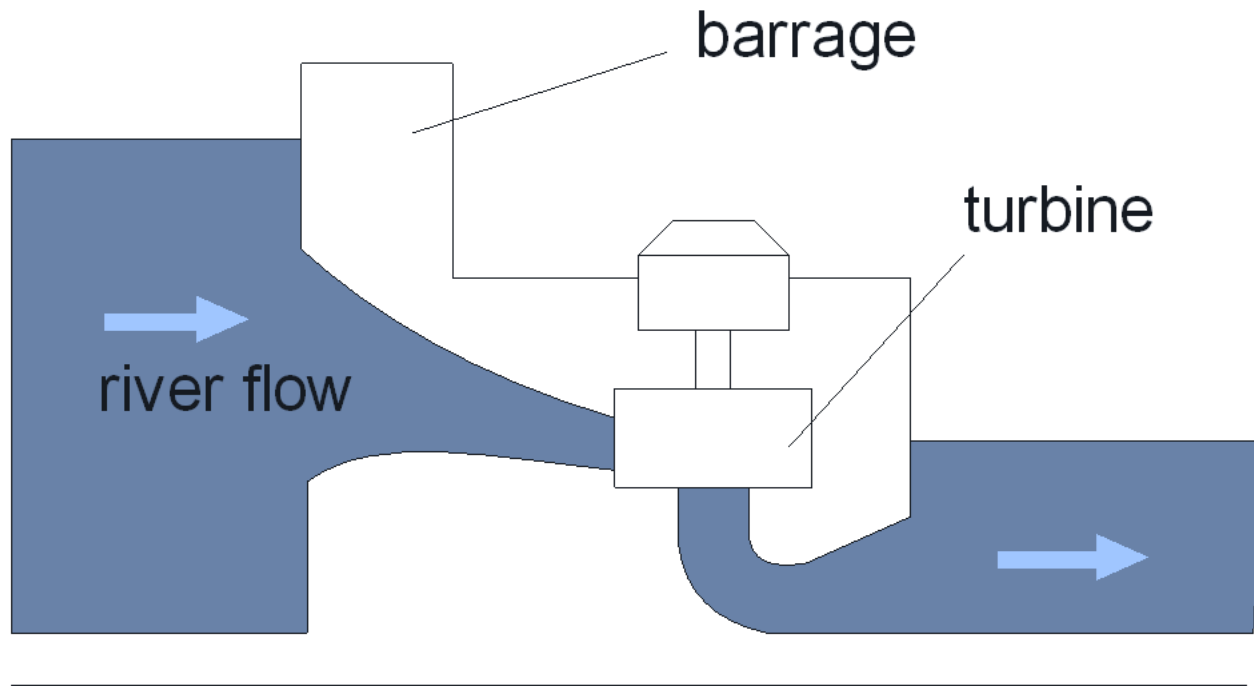

(a) low head

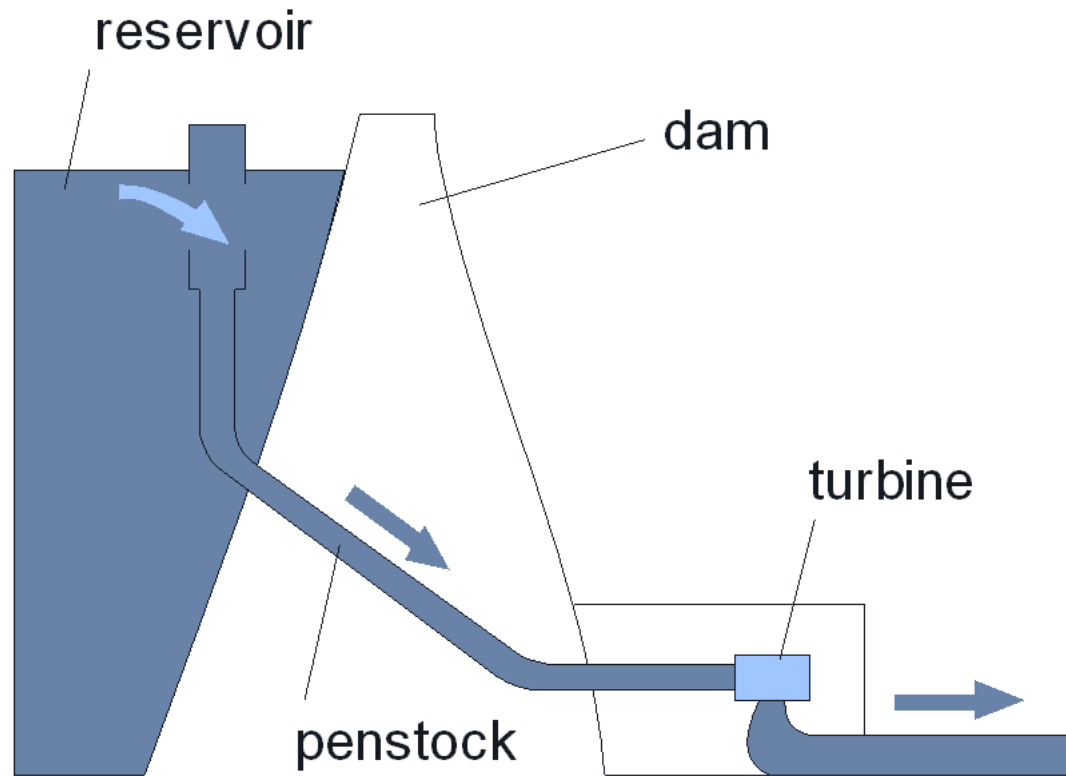

(b) medium head

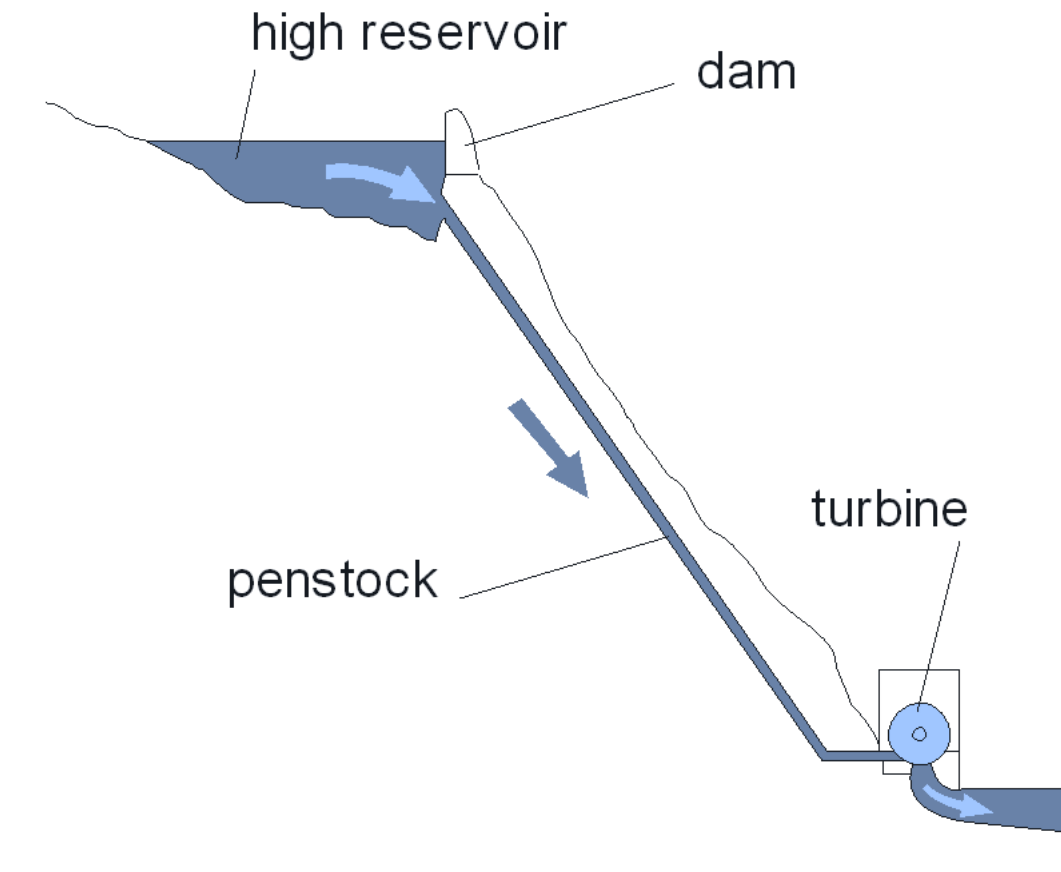

(c) high head

TIPOS DE TURBINA

a)

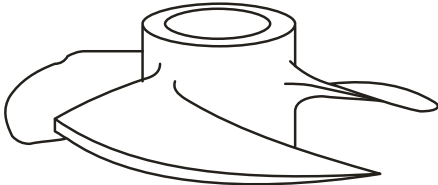

Fixed blades

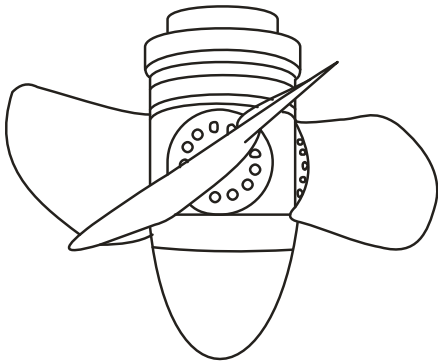

Adjustable blades (Kaplan)

b)

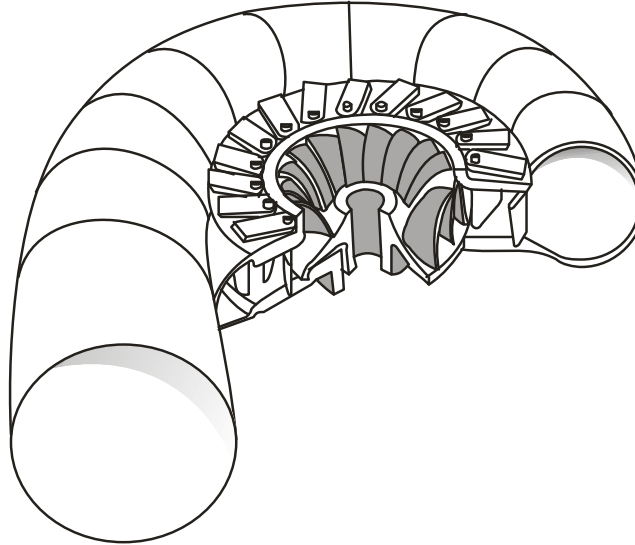

c)

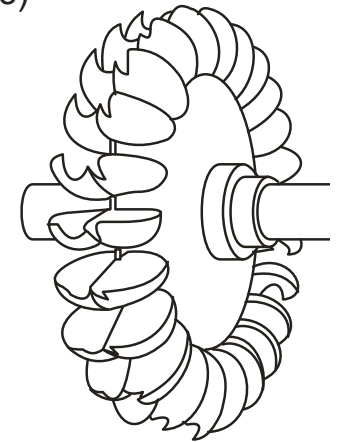

d)

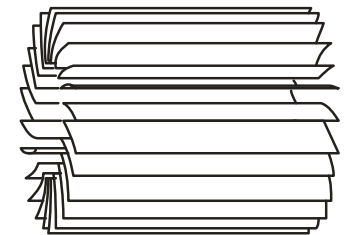

Four runner designs used in hydroelectric turbines: (a) propeller type, with either fixed blades or adjustable blades (the Kaplan turbine), (b) Francis type, (c) Pelton wheel type, and (d) cross-flow type

Turbina Kaplan

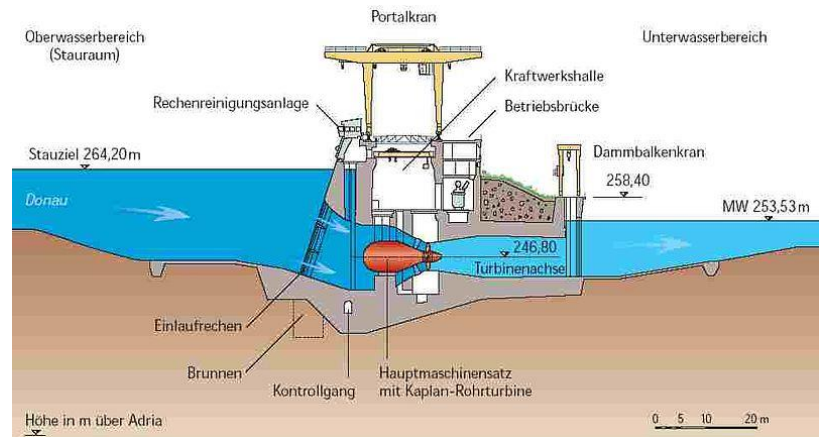
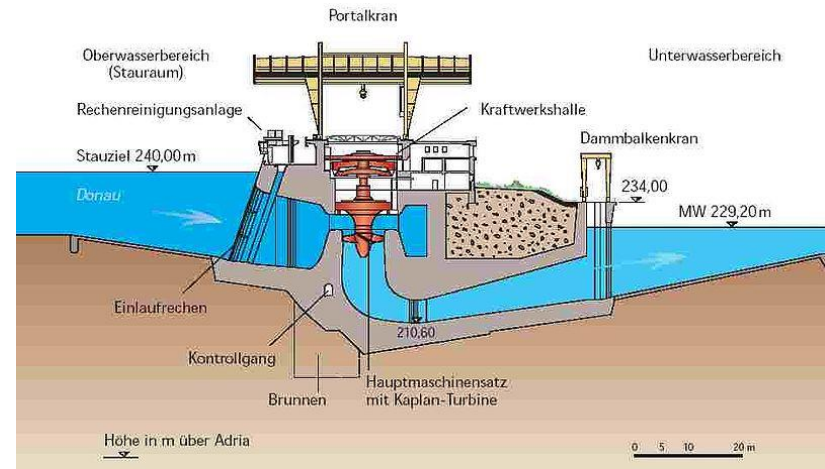
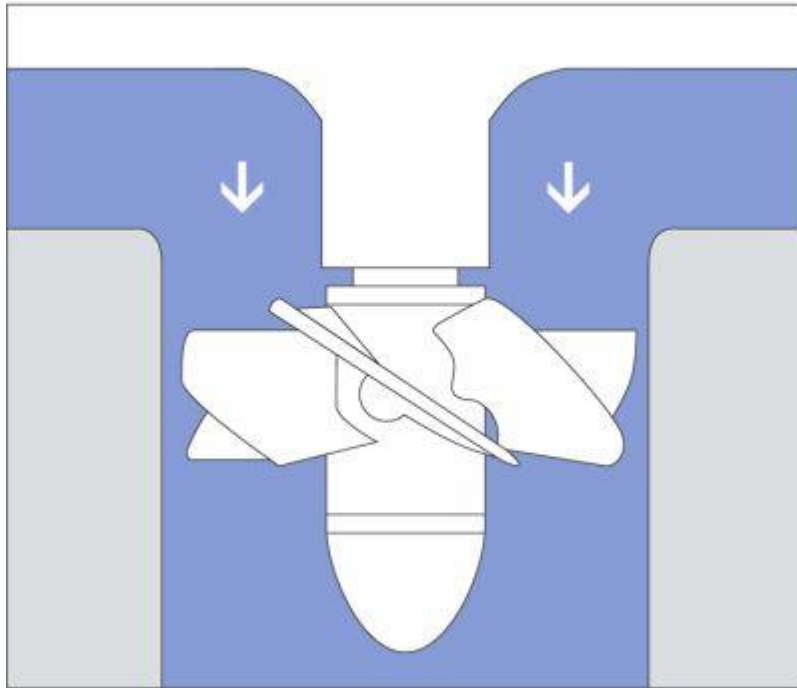

Turbina Francis

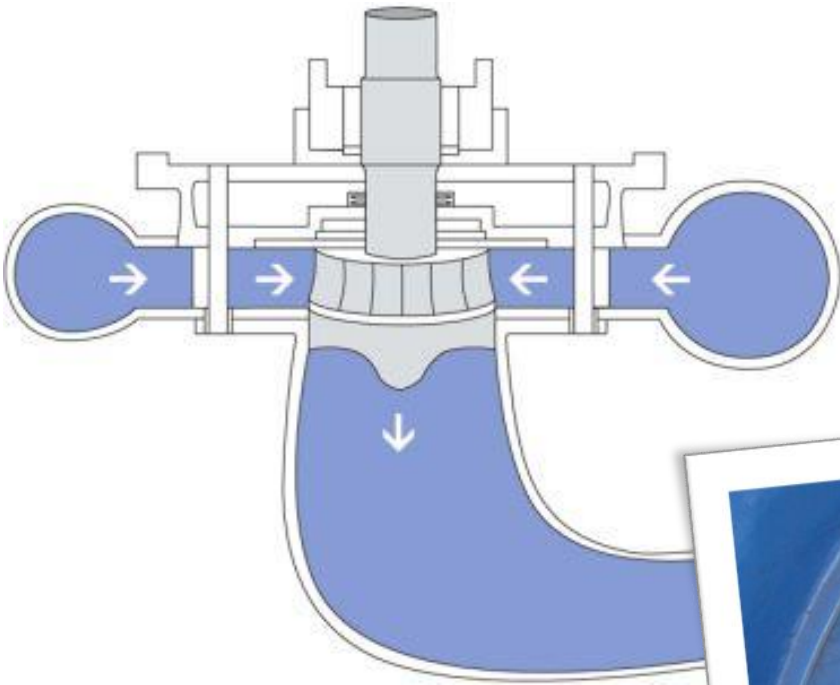



八局
转轮顺利吊入厂房

35
FC 030058

SeaLand

Turbina Pelton

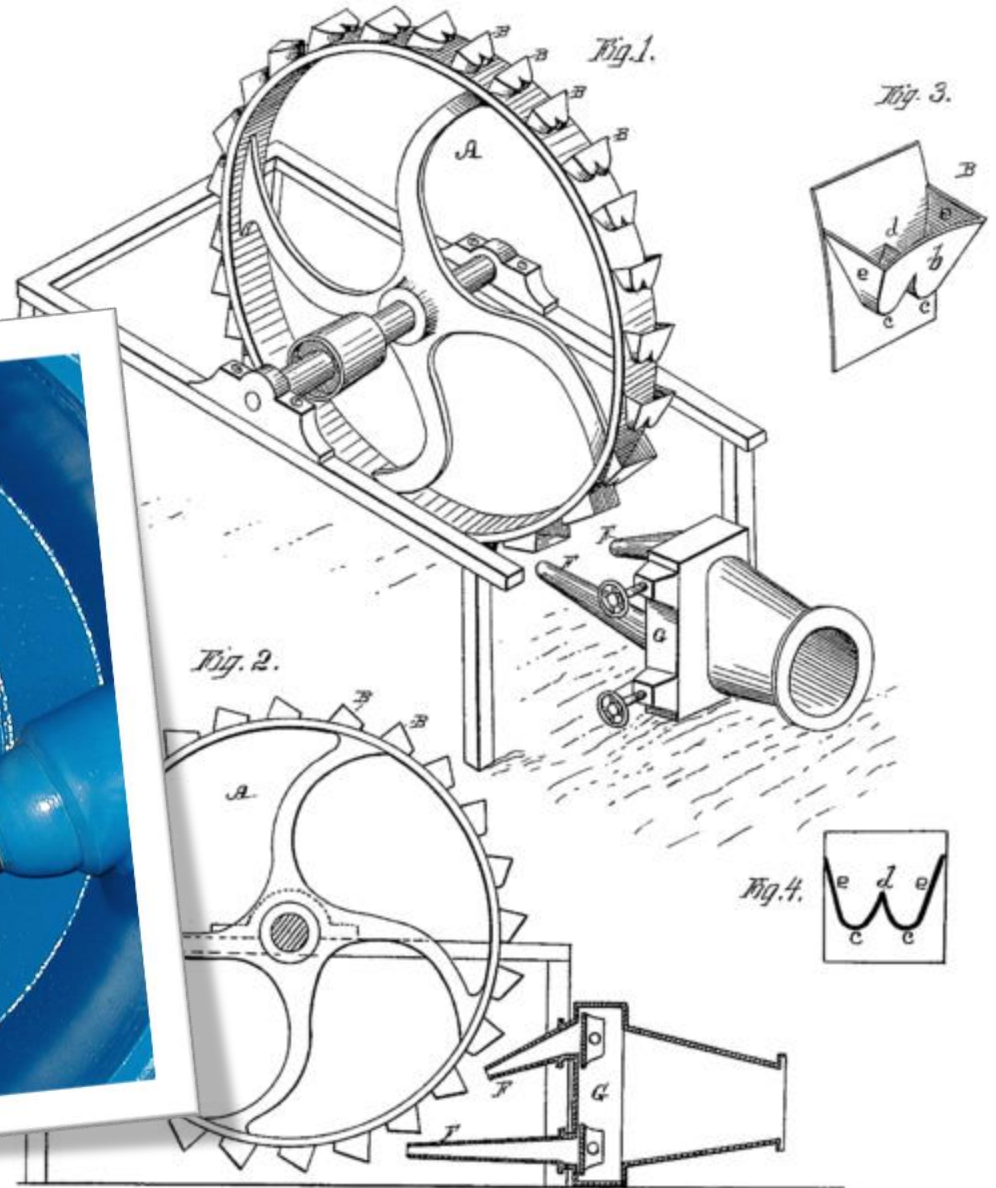

Turbina Banki (cross flow)

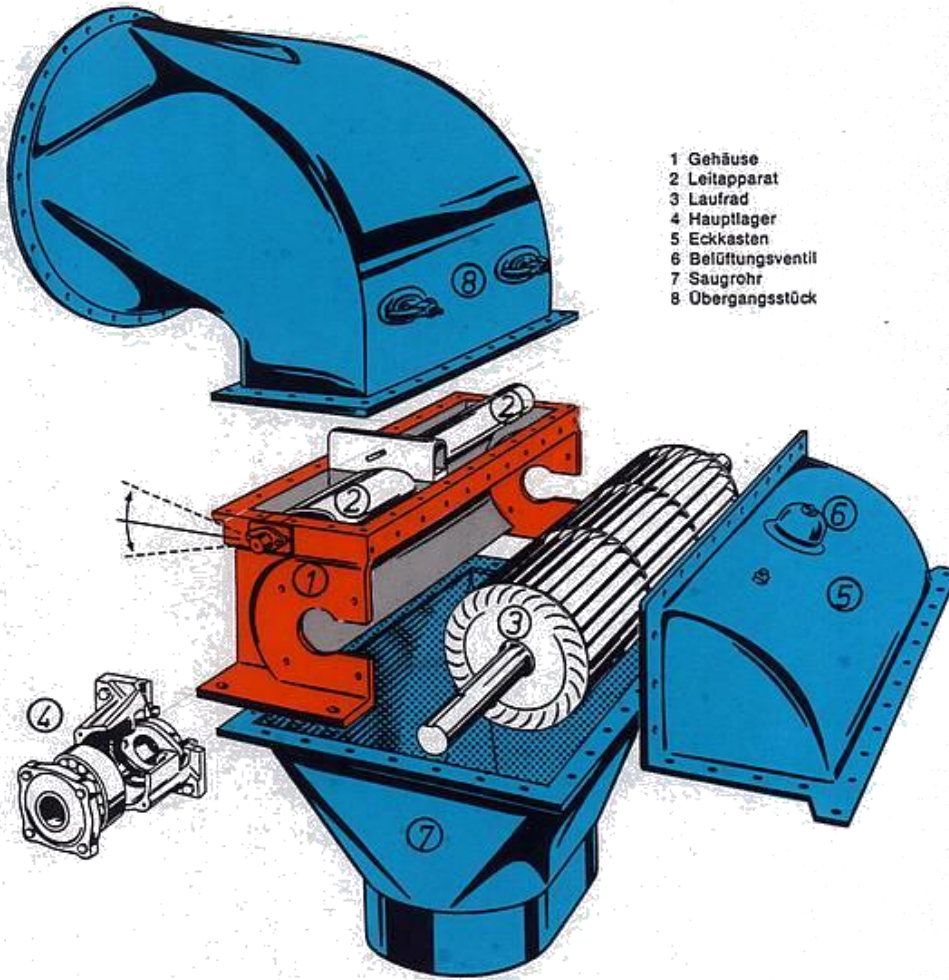

- 1 Gehäuse
- 2 Leitapparat
- 3 Laufrad
- 4 Hauptlager
- 5 Eckkasten
- 6 Belüftungsventil
- 7 Saugrohr
- 8 Übergangstück

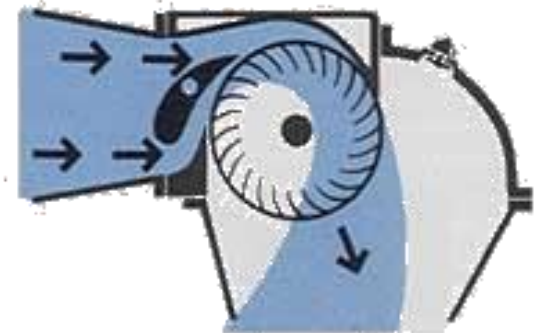
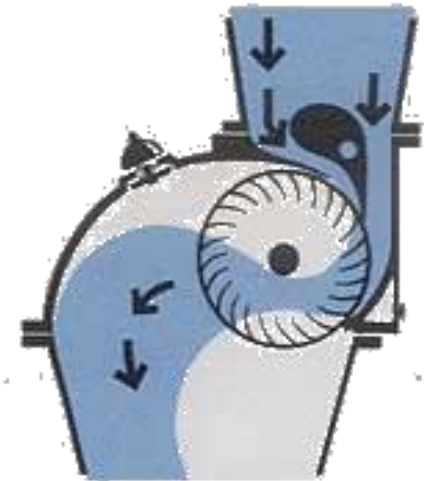

TIPOS DE TURBINA

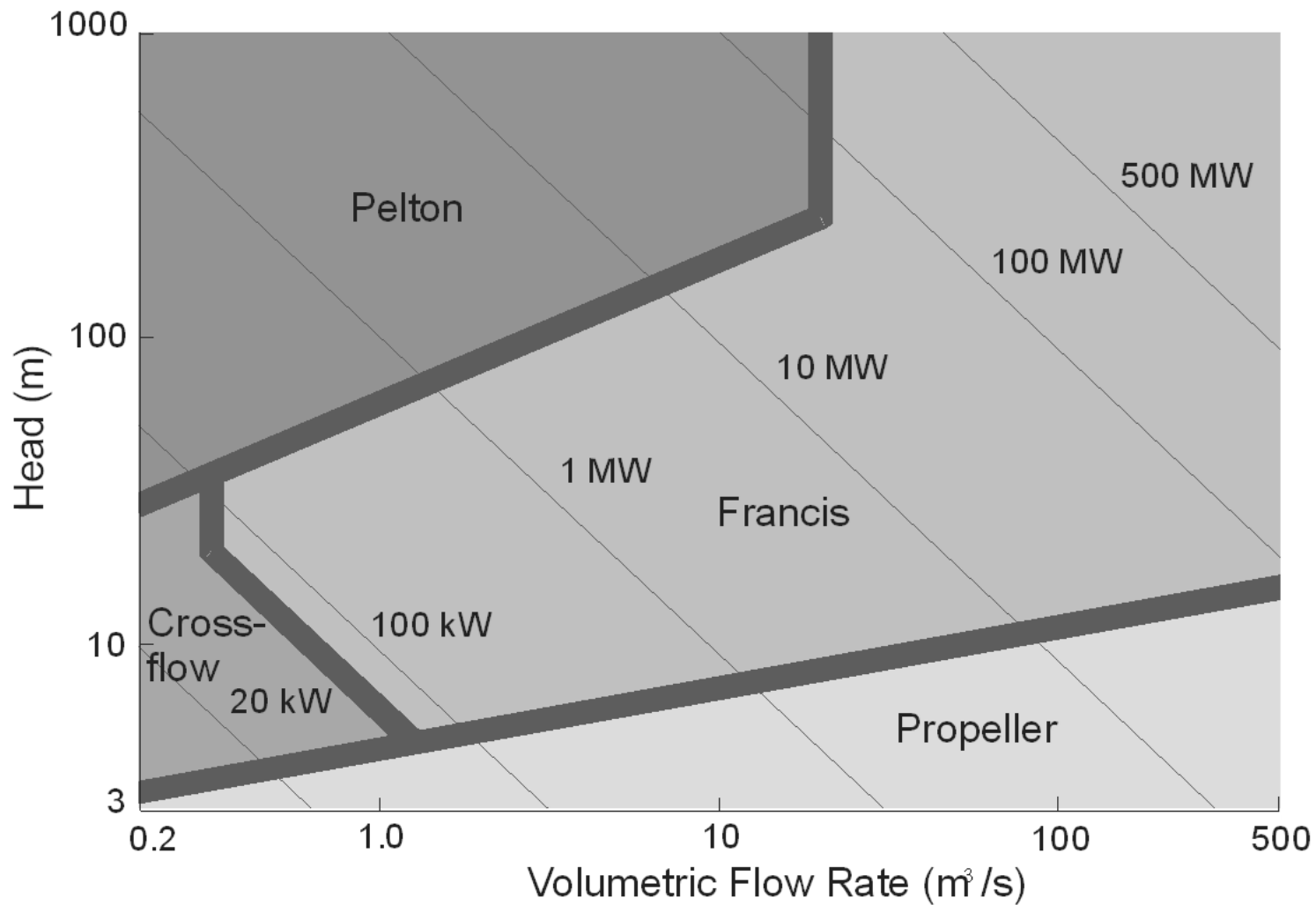

TIPOS DE TURBINA

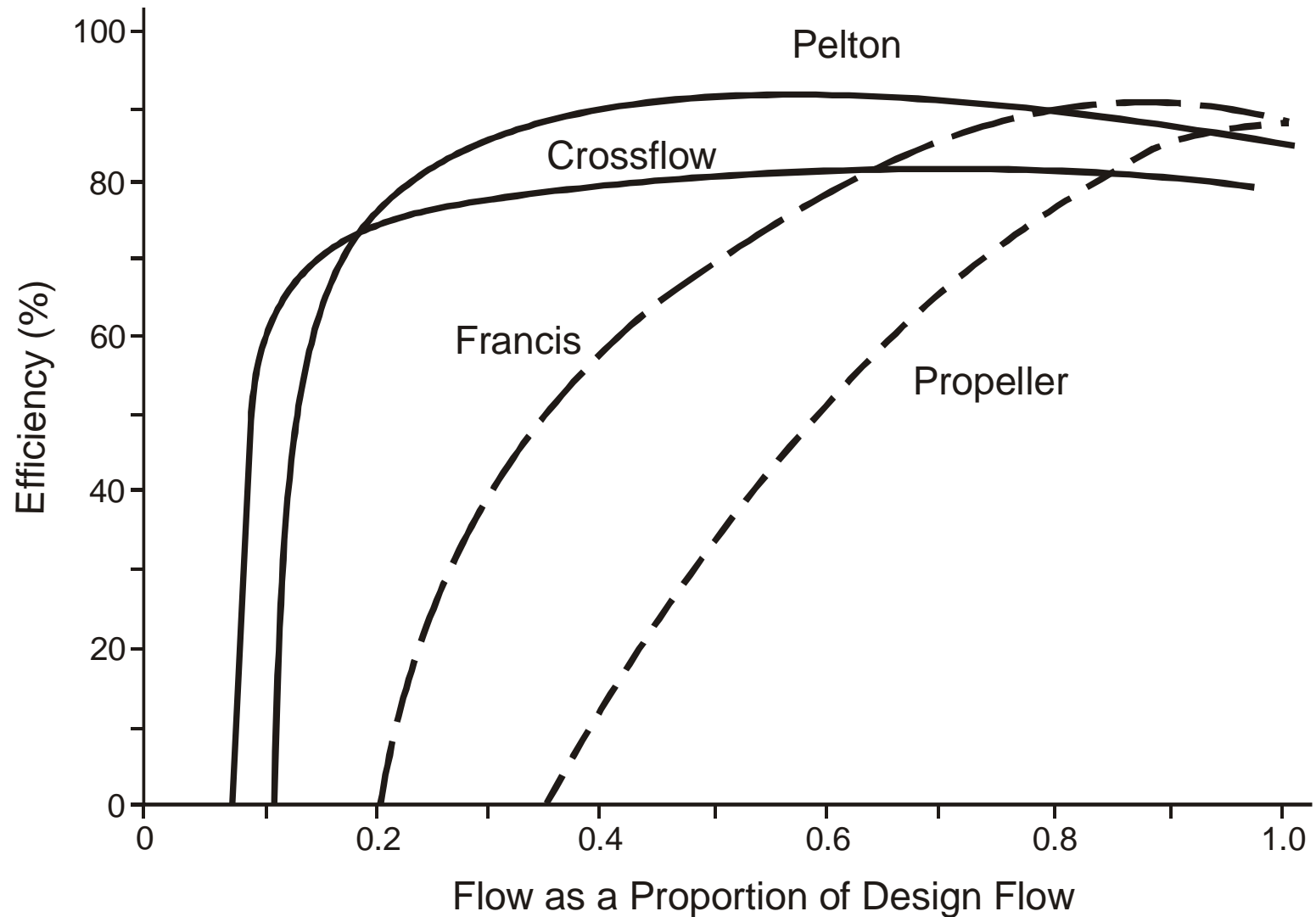

TIPOS DE TURBINA

Limites de exploração das turbinas

Turbina	$\alpha_1 = \frac{Q_{\min}}{Q_N}$	$\alpha_2 = \frac{Q_{\max}}{Q_N}$
Pelton	0,15	1,15
Francis	0,35	1,15
Kaplan com dupla regulação	0,25	1,25
Kaplan com rotor regulado	0,4	1,0
Hélice	0,75	1,0

ENERGIA PRODUZIDA POR UMA CENTRAL HÍDRICA

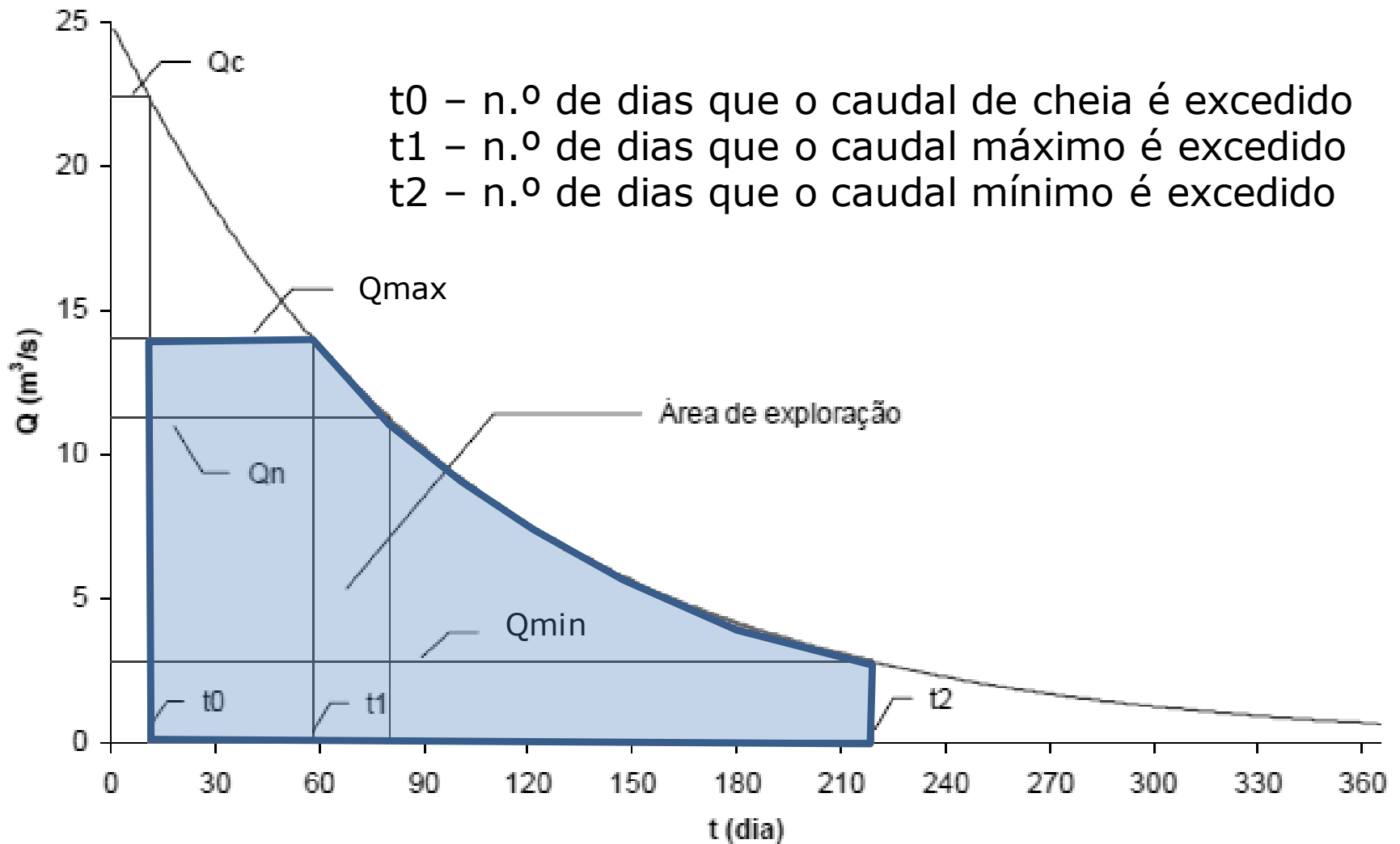

Hydropower generation by region

Hydropower generation is measured in terawatt-hours (TWh) per year.

Our World
in Data

Relative

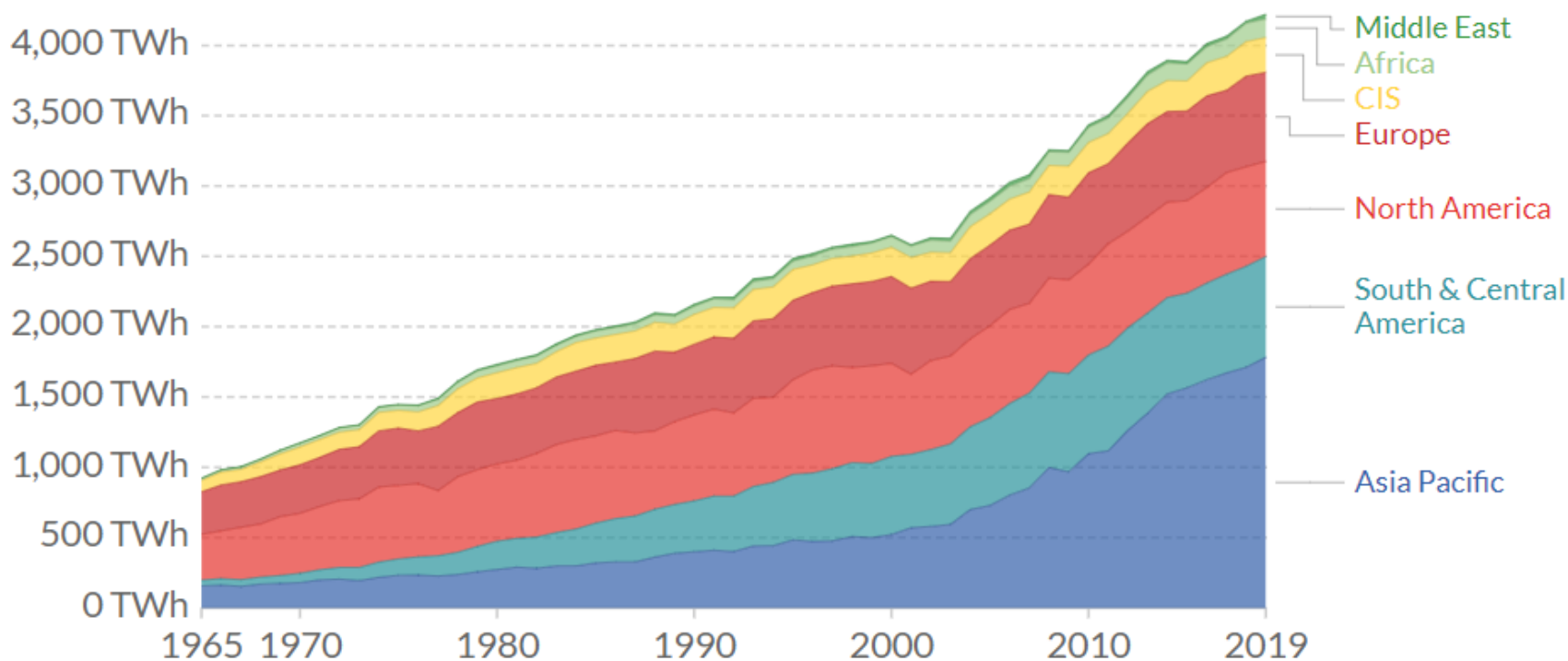

Source: BP Statistical Review of Global Energy (2020)

Note: CIS (Commonwealth of Independent States) is an organization of ten post-Soviet republics in Eurasia following break-up of the Soviet Union



OurWorldInData.org/renewable-energy • CC BY

World hydropower map

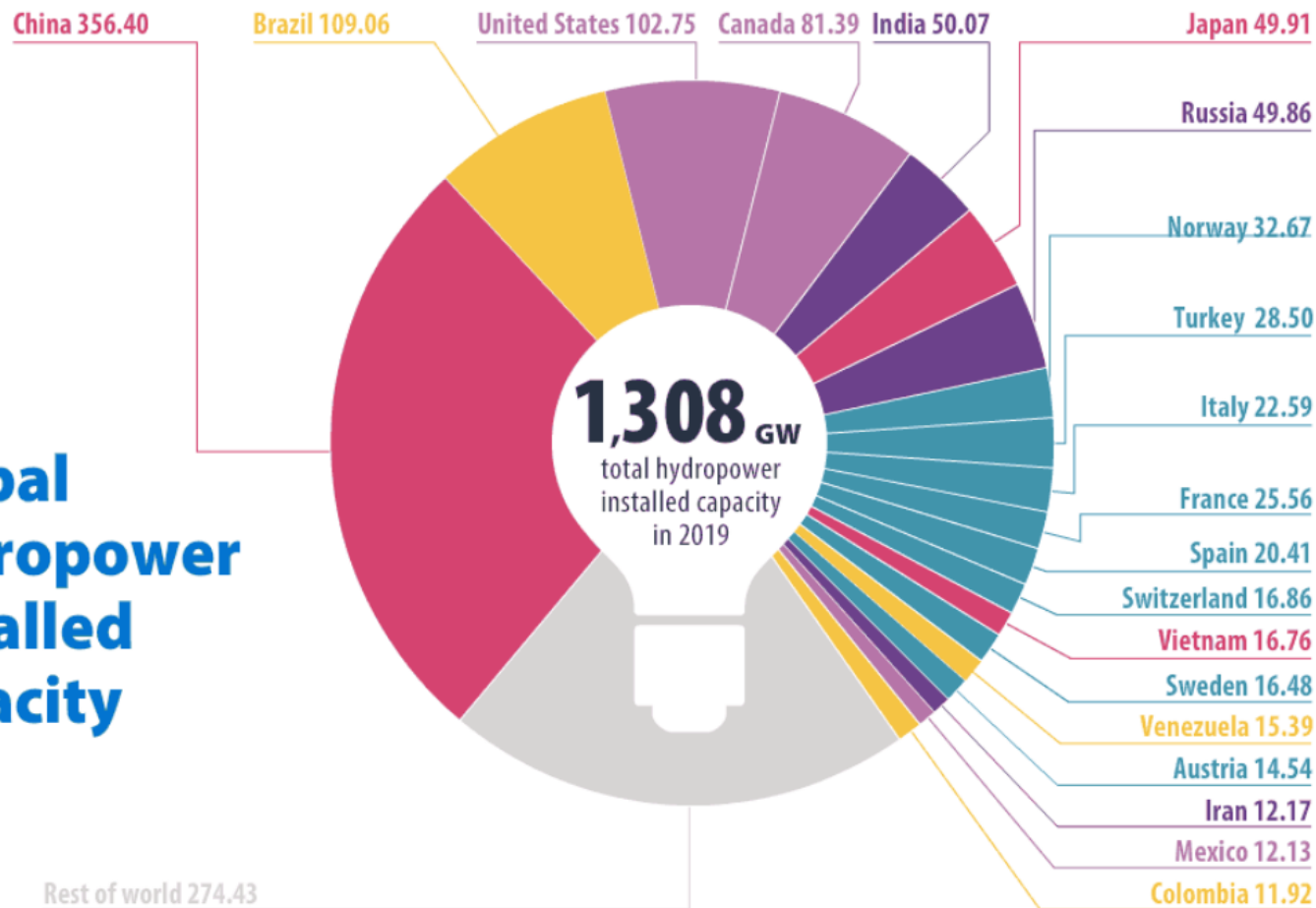
Global hydropower installed capacity



As maiores barragens do mundo

Name		River	Installed	Annual	Area	Years of completion
			capacity	production	flooded	
			(MW)	(TWh)	(km ²)	
Three Gorges Dam		Yangtze	22500	103.1	1084	2008/2012
Itaipu Dam		Paraná	14000	103	1350	1984/1991, 2003
Xiluodu		Jinsha	13,860	55.2		2014
Belo Monte		Xingu	11,233	39.5	441	2016-2019
Guri		Caroní	10235	53.41	4250	1978, 1986
Tucuruí		Tocantins	8370	41.43	3014	1984, 2007
Grand Coulee		Columbia	6809	20	324	1942- 1991
Xiangjiaba		Jinsha	6448	30.7	95.6	2014
Longtan Dam		Hongshui	6426	18.7		2007/2009
Sayano-Shushenskaya		Yenisei	6400	26.8	621	1989, 2014
Krasnoyarsk		Yenisei	6000	15	2000	1967/1972

Share of primary energy from hydroelectric power, 2019

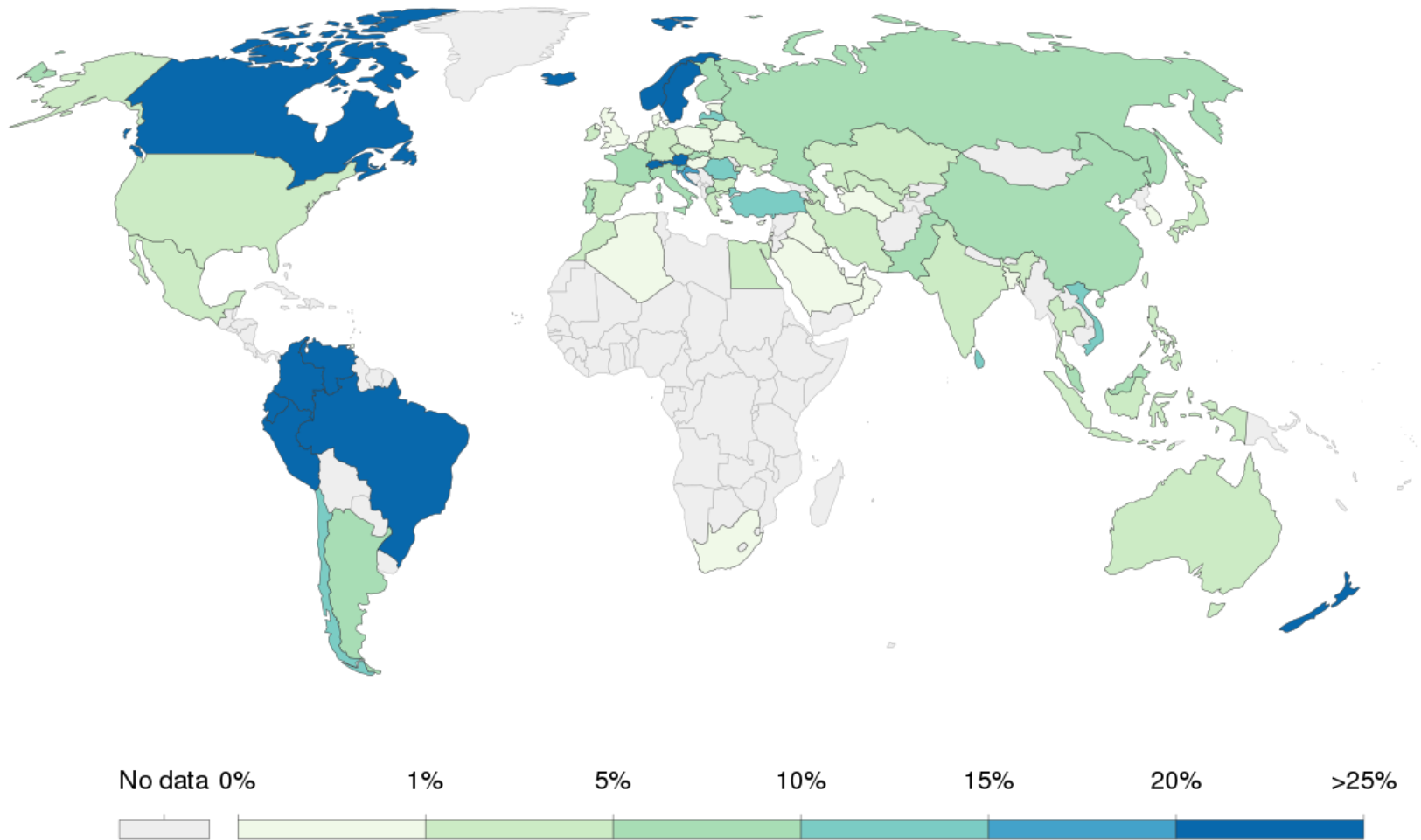

Source: Our World in Data based on BP Statistical Review of World Energy (2020)

Note: Primary energy is calculated using the 'substitution method' which takes account of the inefficiencies energy production from fossil fuels.

China

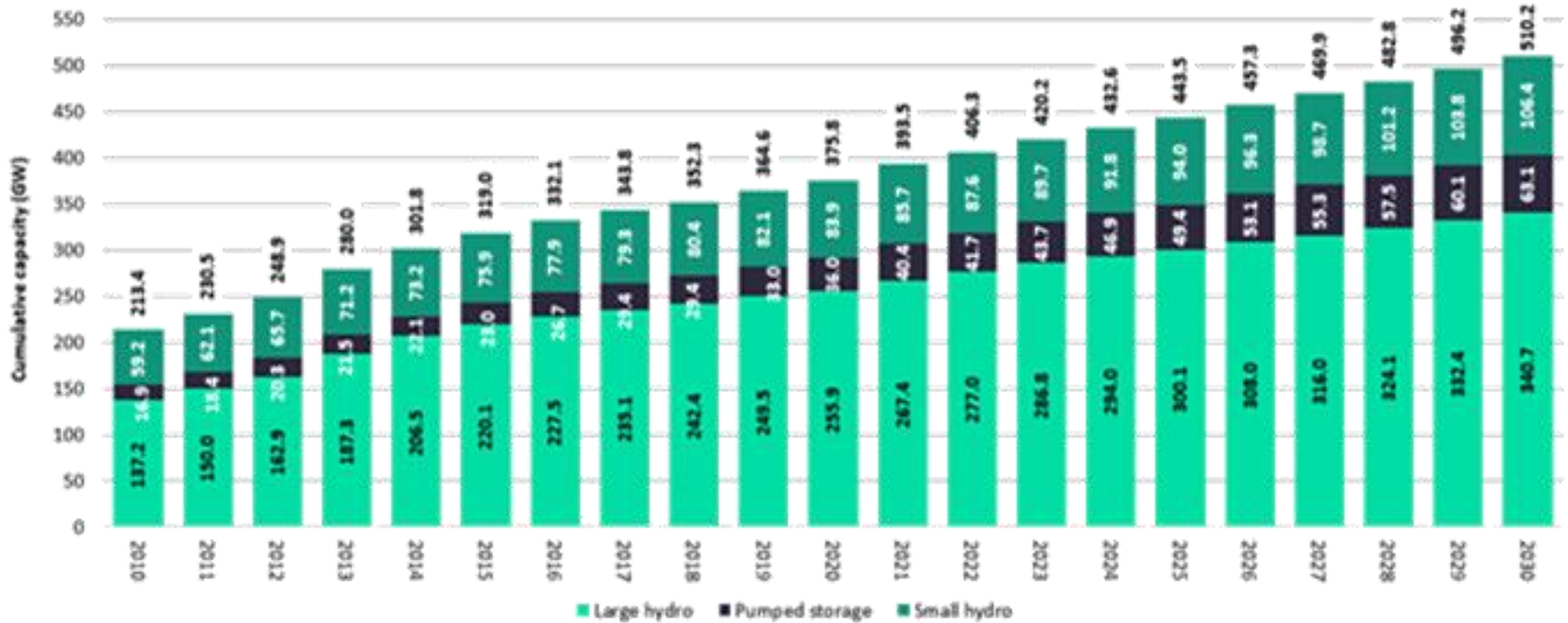

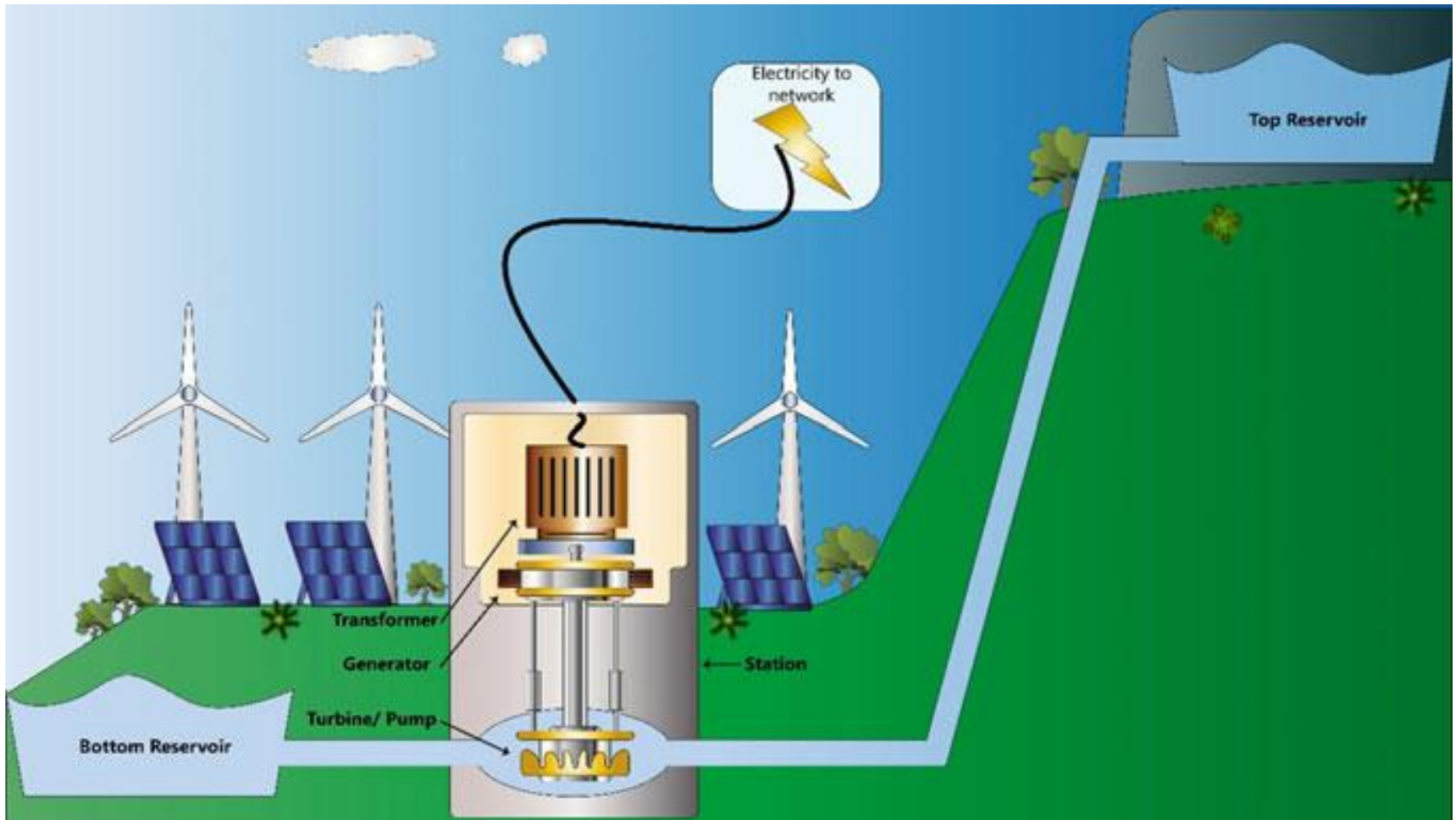

158
GW

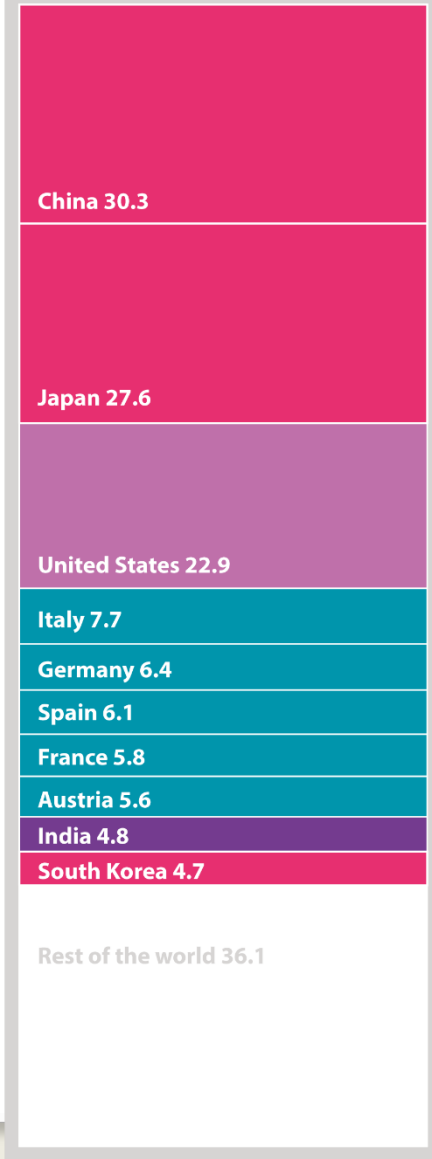

Global pumped storage installed capacity

CAPACIDADE INSTALADA

Pequena hídrica (<10MW)

PAÍS	< 10 MW		Percentagem do total	
	GW	TWh/yr	Potência	Energia
China	9.5		5%	
Japão	3.48		13%	
EUA	2.84	10.7	4%	4%
Itália	2.41	7.6	14%	21%
França	2.02	5.8	8%	10%
Espanha	1.79	4.7	10%	20%
Brazil	1.43	6.7	2%	2%
Austria	0.99	4	8%	10%
Suécia	0.99	3.8	6%	5%
Répubblica Checa	0.28	1.1	28%	45%
Peru	0.23	1	7%	6%
Europa	12.5		10%	
América Norte	5.1			

POTENCIAL HIDROELÉCTRICO

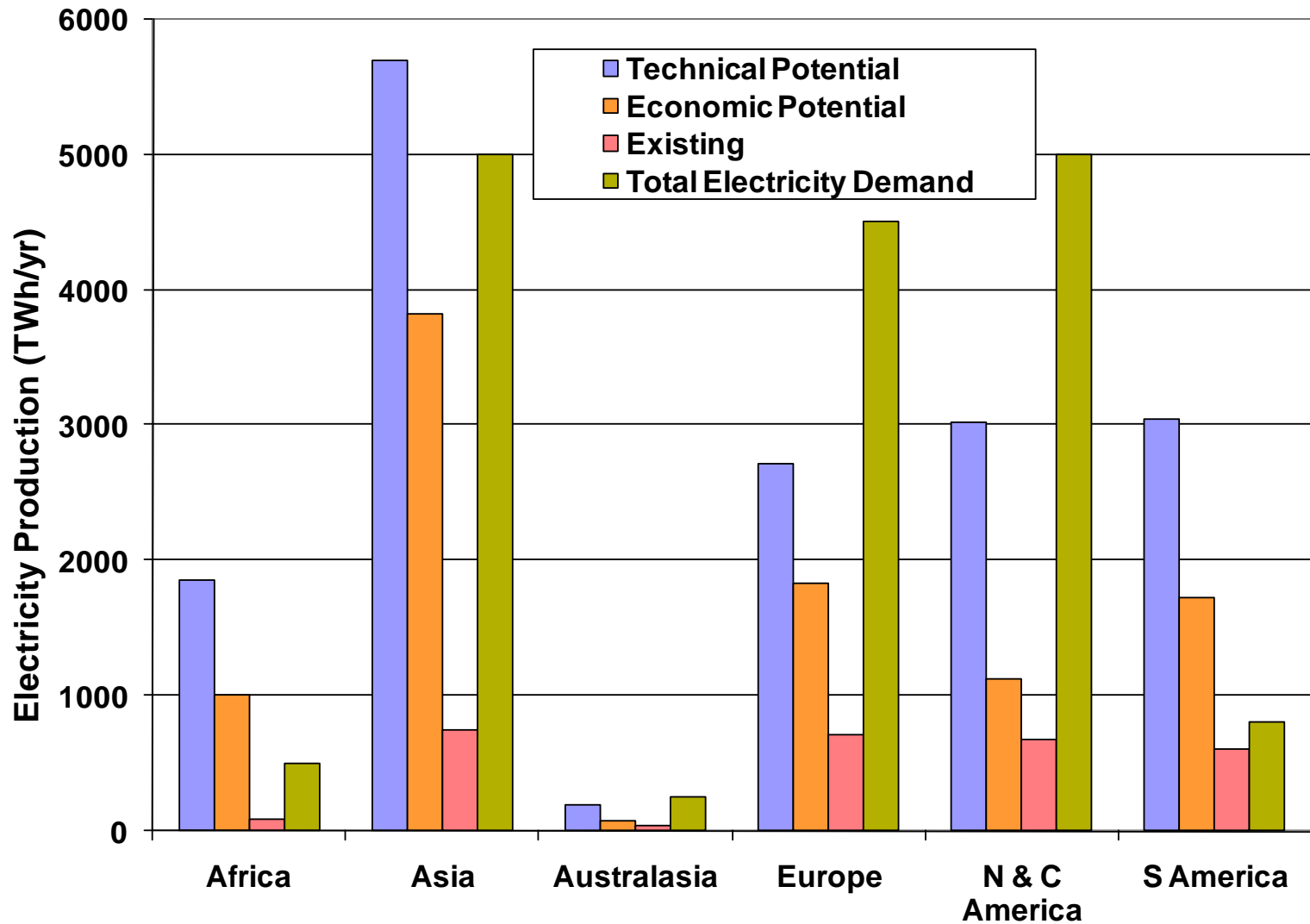

O potencial das mini-hídricas para a eletrificação remota

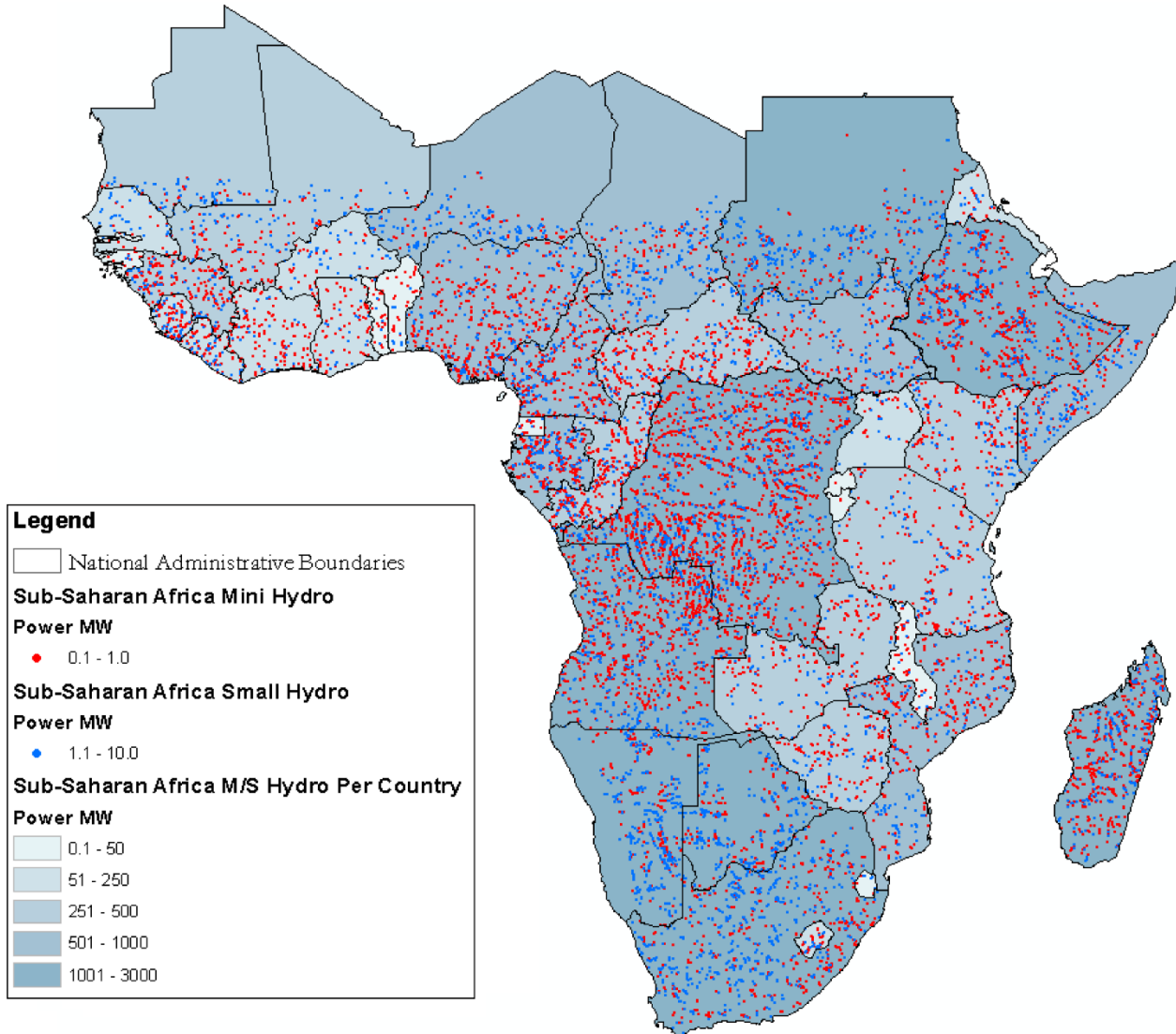

DENSIDADE DE POTÊNCIA

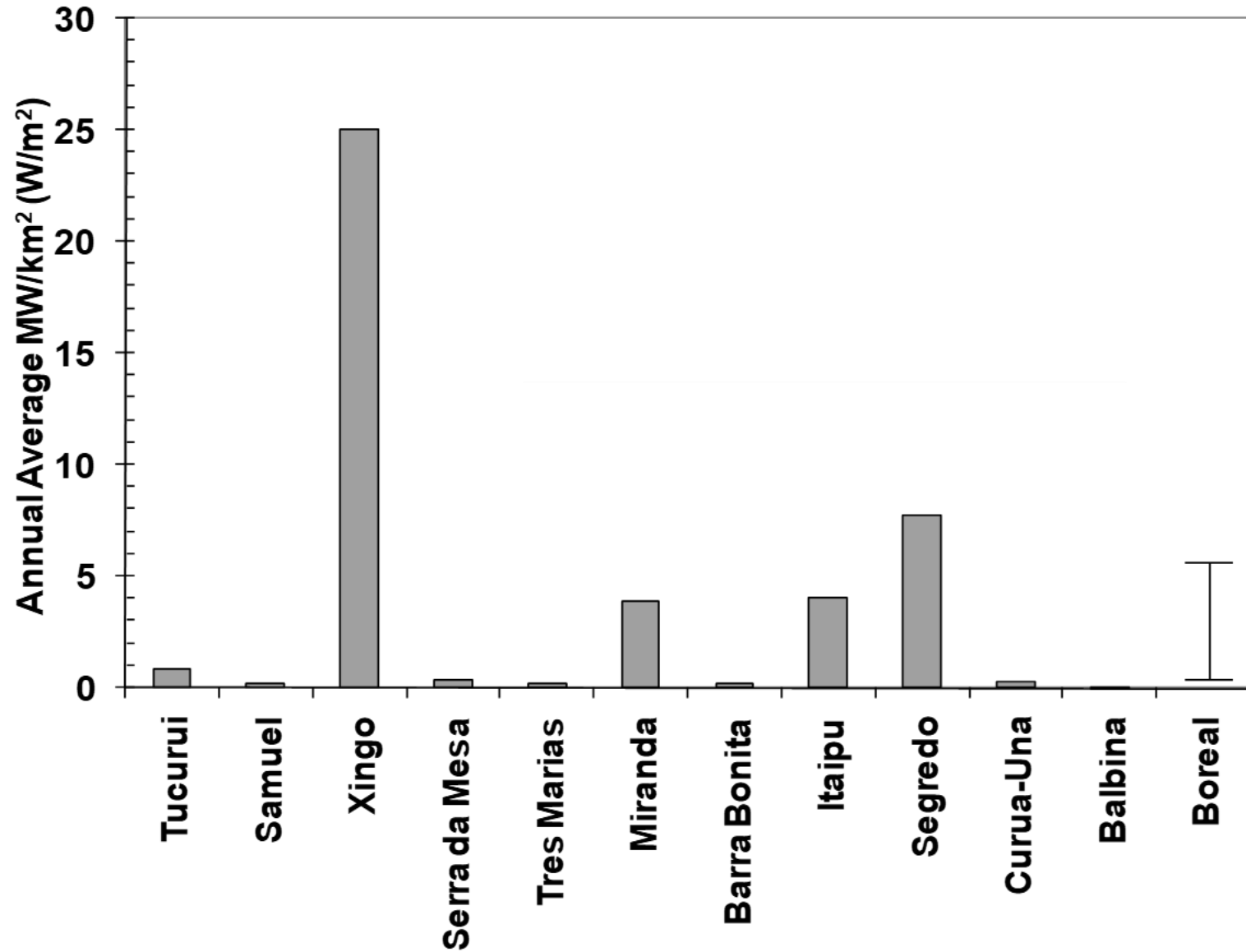

CUSTOS INVESTIMENTO

- Pequena hídrica, \$1000-3000/kW, países em desenvolvimento
- Pequena hídrica, \$2000-9000/kW, países desenvolvidos
- Grande hídrica (incluindo barragem e albufeira), \$2000-8000/kW

CUSTOS INVESTIMENTO

Pequena hídrica (<10MW)

Depende da queda de água e potência, e do factor de utilização

Tabela 3: Investimento unitário (€/kW) em CMH (final de 2002) [ESTIR]

€/kW	Mínimo	Máximo	Médio
1MW-10MW	600	2000	1300
500kW-1MW	1300	4500	2900
100kW-500kW	1500	6000	3750
<100kW	1500	6000	3750

Energy Scientific & Technological Indicators and References (ESTIR), Area: Electricity Generation, Sector: Hydropower (incl. small), Community Research & Development Information Service (CORDIS), 2002.

CUSTOS INVESTIMENTO

Pequena hídrica (<10MW)

Depende da queda de água e potência, e do factor de utilização

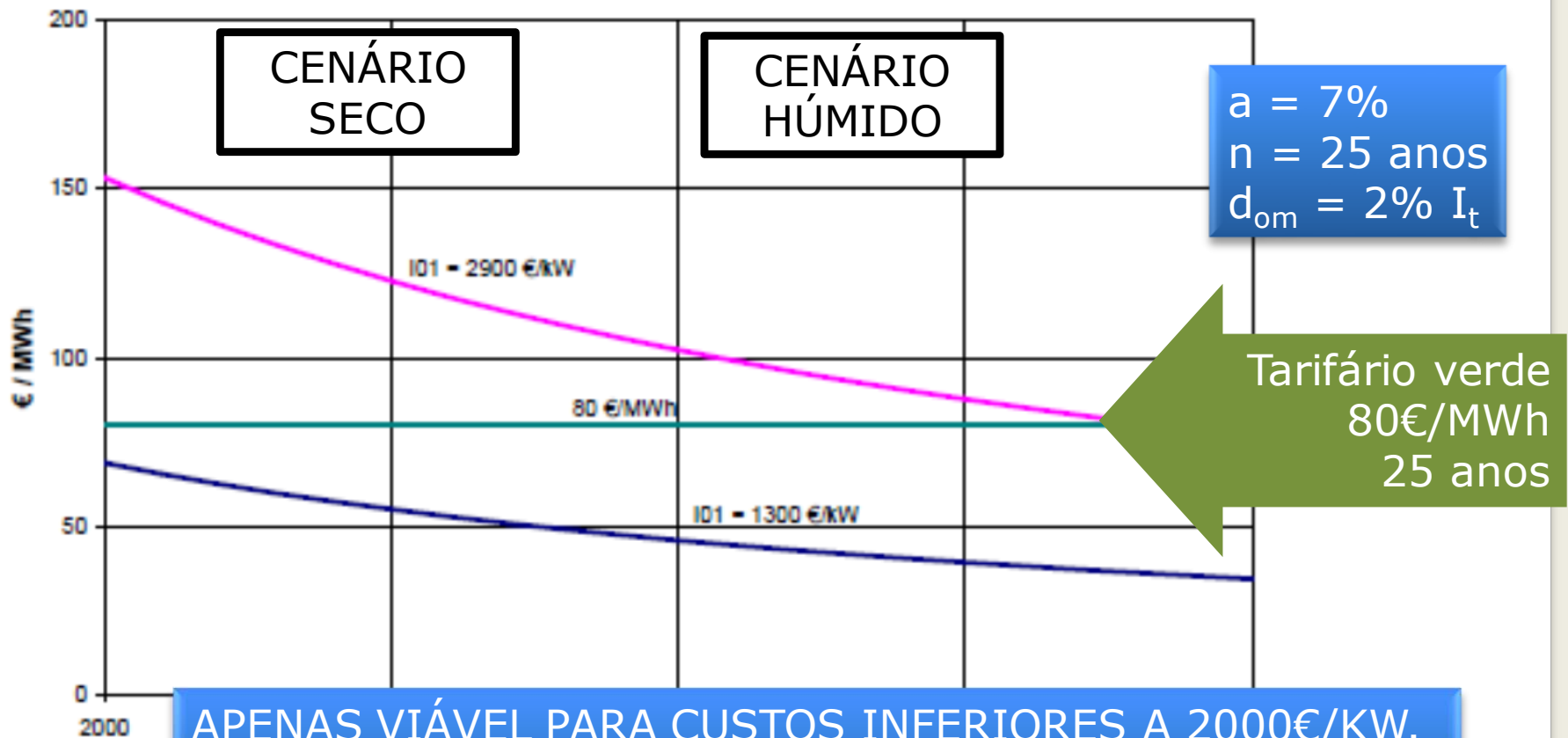

IMPACTOS POSITIVOS

Impactos económicos & energéticos

- Custo da energia
- Segurança energética (fonte endógena, ou quase)
- Valorização recurso eólico (PNBEPH: 1MW de bombeagem/ 3.5MW de eólico)
- Aproveitamento água para consumo das populações e/ou irrigação

IMPACTOS NEGATIVOS

Impactos sociais

- Deslocamento população
- Reservatório pode promover desenvolvimento vectores transmissão doenças
- (Acidentes: Banqiao, 170000 mortos em 1975)

IMPACTOS NEGATIVOS

Impactos ambientais

- Maior área de superfície = maiores perdas evaporação
- Sedimentação antes da barragem (= custos manutenção)
- Menos sedimentação depois da barragem (= erosão costeira)
- Fragmentação ecossistema fluvial (efeito na biodiversidade)
- Alteração paisagem
- Desflorestação
- Emissões metano

EMISSÕES

Emissões GHG barragens Brasil

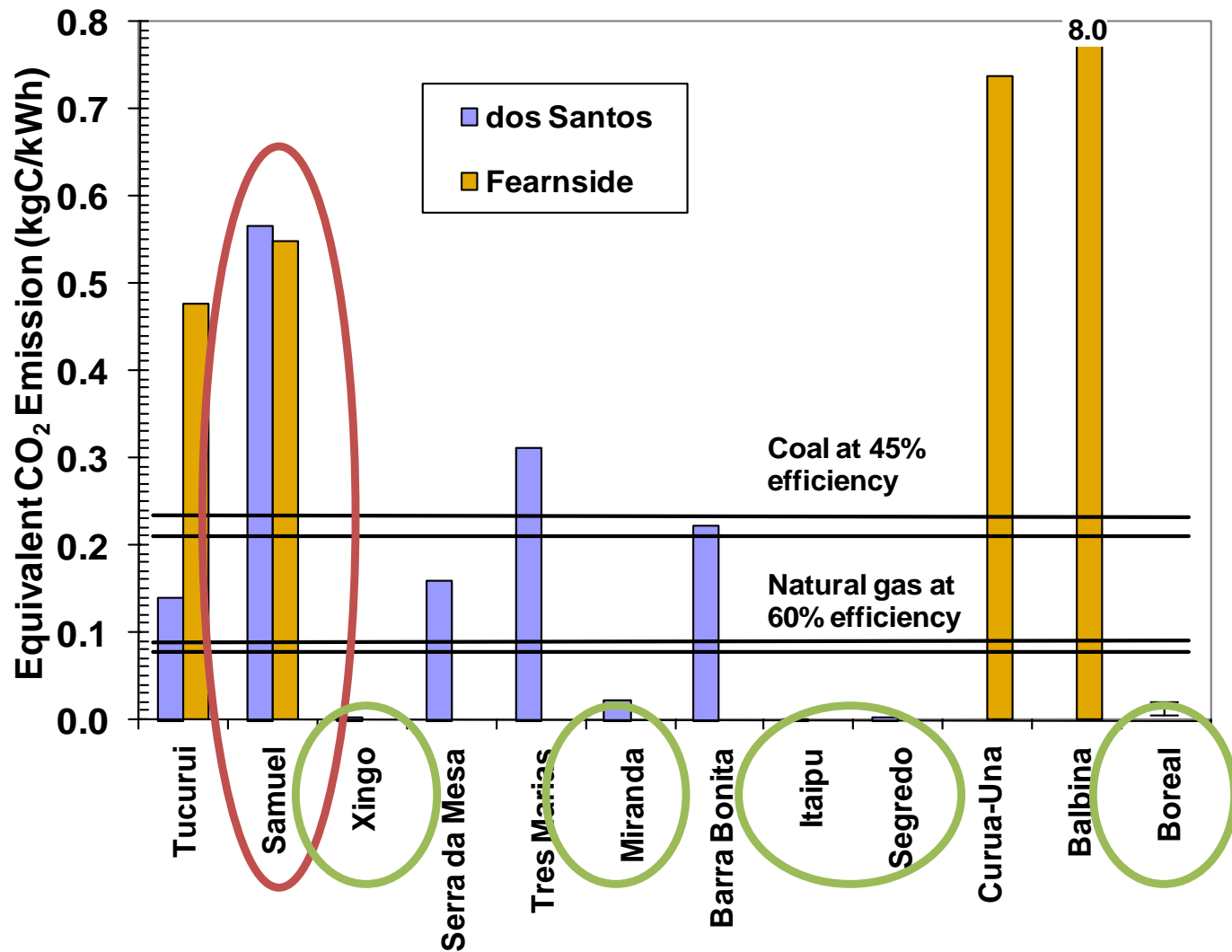

EMISSÕES

Emissões GHG barragens Brasil (excepto *Boreal*)

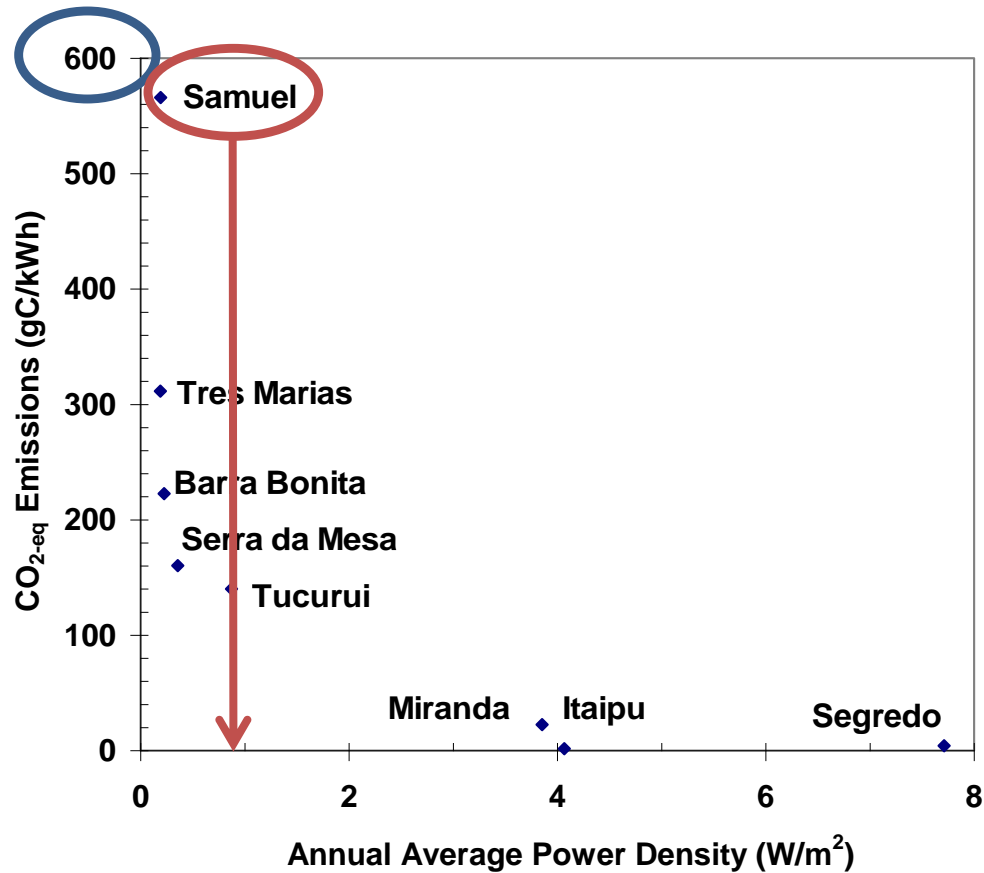

EMISSÕES

Emissões GHG barragens Quebec

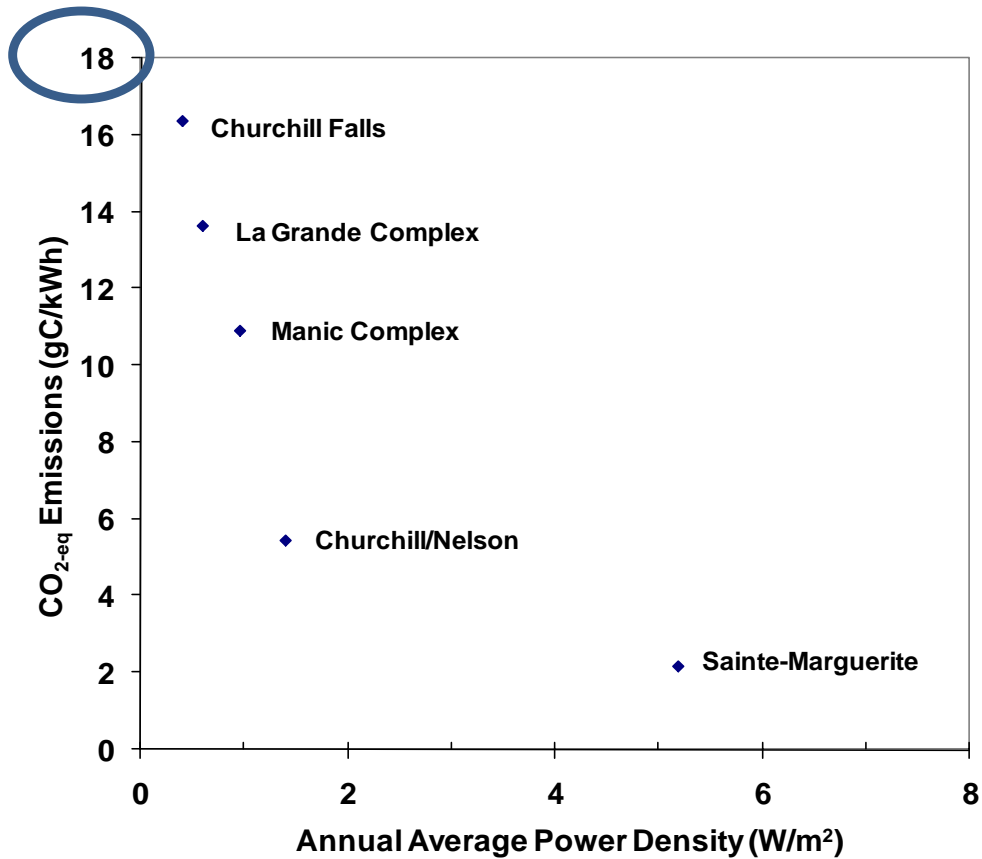

PORTUGAL

Grande hídrica

Quadro 1.2.4 – Capacidade de armazenamento e potência hidroeléctrica instalada por bacia hidrográfica

Bacia hidrográfica	Afluências anuais actuais (hm ³)	Capacidade útil das albufeiras (hm ³)	Capacidade útil das albufeiras em % das afluências	Potência hidroeléctrica (MW)
Lima	3 000	355	12%	650
Cávado	2 300	1 142	50%	630
Douro	18 500	380	2%	2 000
Vouga	2 000	0	0%	0
Mondego	3 350	361	11%	500
Tejo	12 000	2 355	20%	570
Guadiana	4 500	3 244	72%	250
Sado	1 460	444	30%	0
Mira	330	240	73%	0
Ribeiras Algarve	400	341	85%	0
Total	47 800	8 862	19%	4 600



Figura 1.2.13 – Grandes aproveitamentos hidráulicos existentes

PORTUGAL

(Nova) grande hídrica

Principais características dos aproveitamentos seleccionados para o PNBEPH

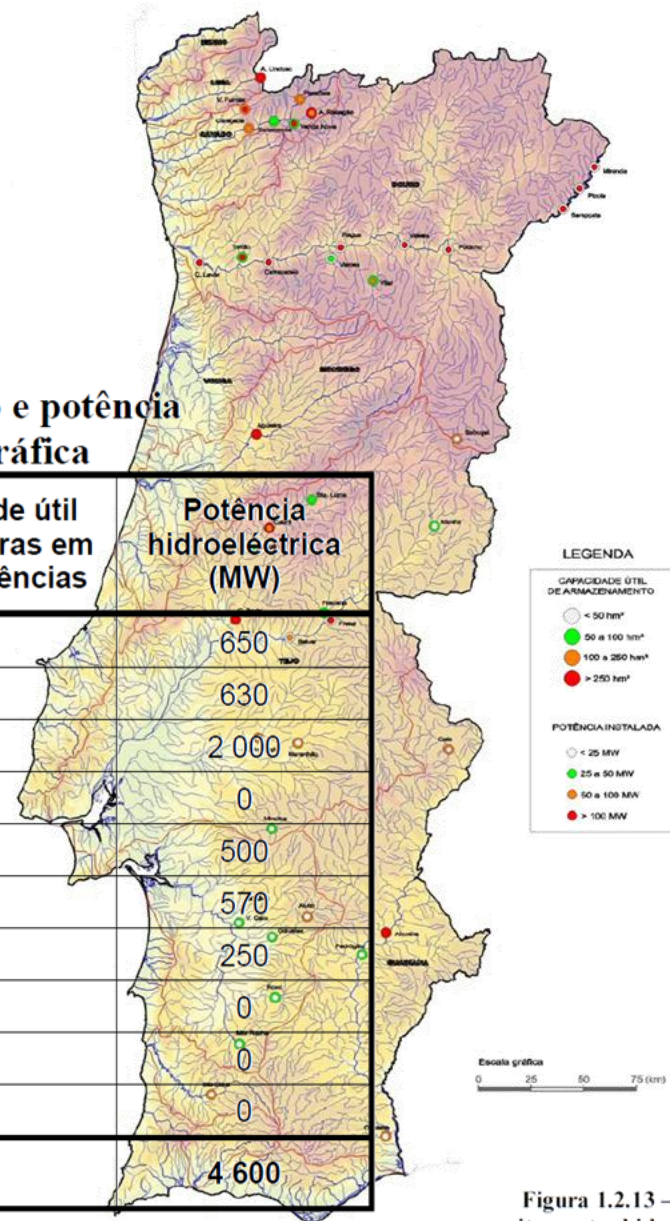
APROVEITAMENTO	BACIA HIDROGRÁFICA	RIO	TIPO	ÁREA DA BACIA HIDROGRÁFICA (km ²)	CAPACIDADE DA ALBUFEIRA (hm ³)	POTÊNCIA INSTALADA (MW)	ENERGIA PRODUZIDA (GWh/ano)
Foz Tua	Douro	Tua	Reversível	3 822	310	234	340
Fridão	Douro	Tâmega	-	2 630	195	163	299
Padroselos	Douro	Beça/Tâmega	Reversível	315	147	113	102
Gouvães	Douro	Torno/Tâmega	Reversível	100	13	112	153
Daivões	Douro	Tâmega	Reversível	1 984	66	109	148
Alto Tâmega (Vidago)	Douro	Tâmega	Reversível	1 557	96	90	114
Almourol	Tejo	Tejo	-	67 323	20	78	209
Pinhosão	Vouga	Vouga	Reversível	401	68	77	106
Girabolhos	Mondego	Mondego	Reversível	980	143	72	99
Alvito	Tejo	Ocreza	-	968	209	48	62
TOTAL					1 266	1 096	1 632

Figura 7.1 – Localização dos aproveitamentos seleccionados para o PNBEPH

Barragens

Rios

Tipos de utilização ⓘ

- Energia
- Recreio
- Abastecimento
- Indefinido
- Derivação
- Navegação
- S.A.
- Defesa de Cheias
- Irrigação
- Outros

% de armazenamento

- Bacias Hidrográficas
- Barragens



BARRAGENS.PT

% Armazenamento

- 0 - 20
- 21 - 40
- 41 - 50
- 51 - 60
- 61 - 80
- 81 - 100

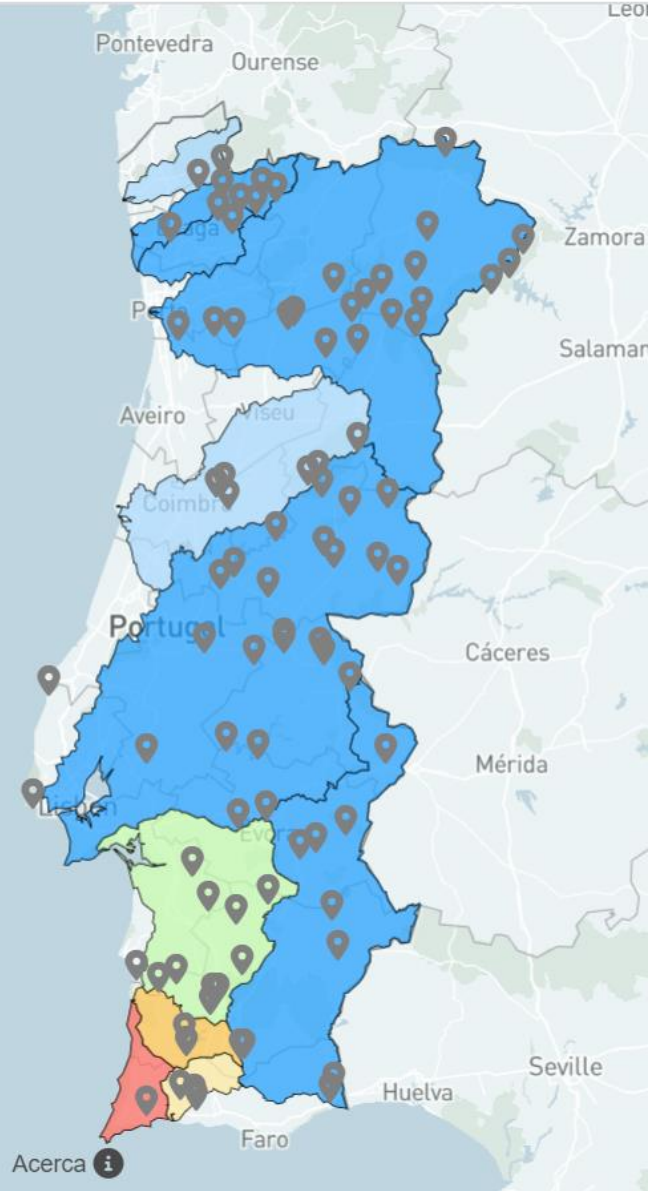

Barragens

Pesquisar... 🔍

Rios

▼

Tipos de utilização ⓘ

- Energia
- Recreio
- Abastecimento
- Indefinido
- Derivação
- Navegação
- S.A.
- Defesa de Cheias
- Irrigação
- Outros

% de armazenamento

- Bacias Hidrográficas
- Barragens



BARRAGENS.PT

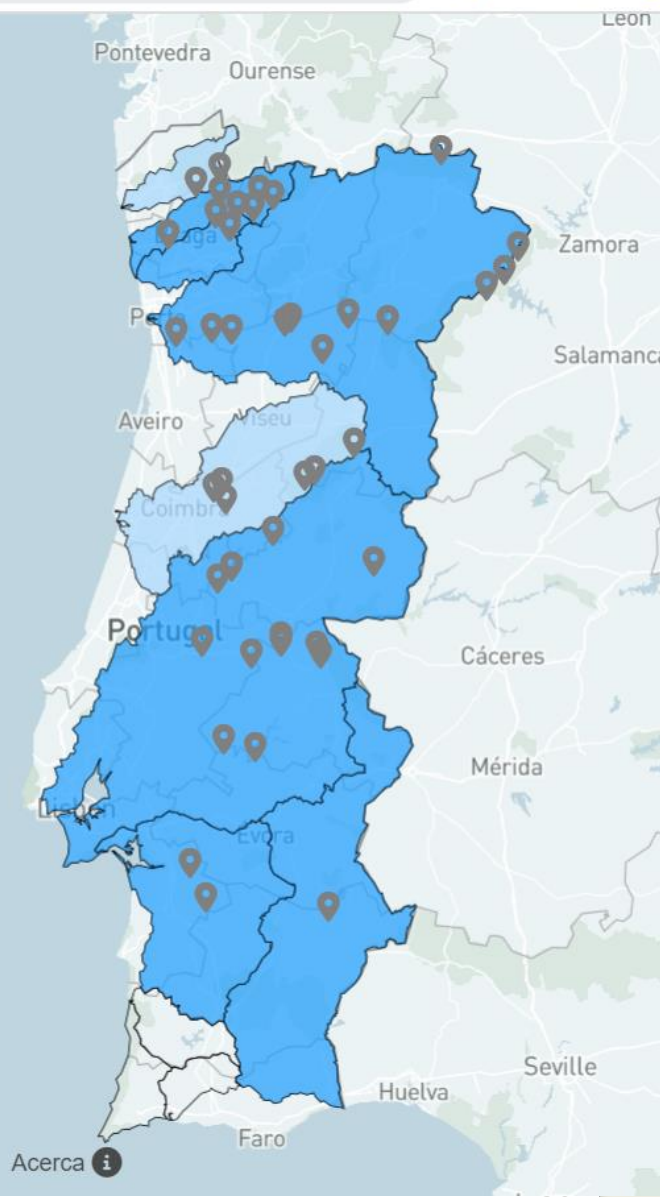
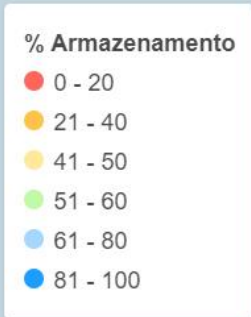

PORTUGAL

Pequena hídrica

115 pequenos aproveitamentos hidroeléctricos (≤ 10 MW), com potência global de cerca de 340 MW.

